

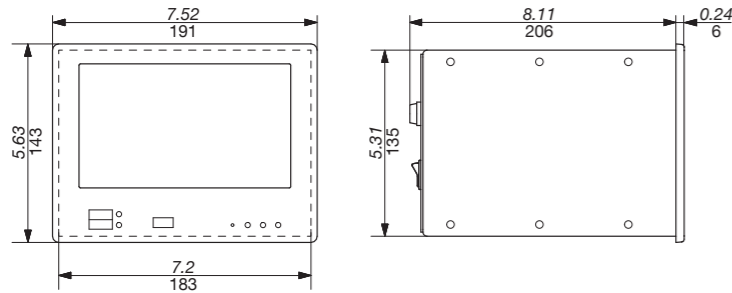

# 1 Dimensions in/mm

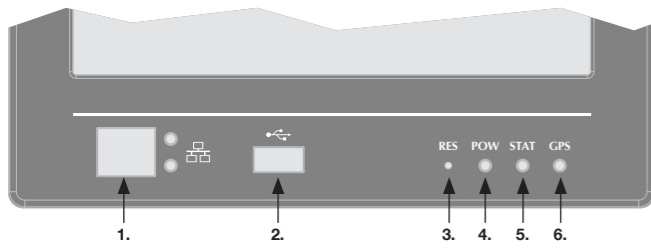

# 3



1. Front Ethernet port
2. USB host port
3. Set default/Reset button
4. LED auxiliary power supply status
5. LED instrument operating status
6. LED RTC synchro status with GPS

# 8

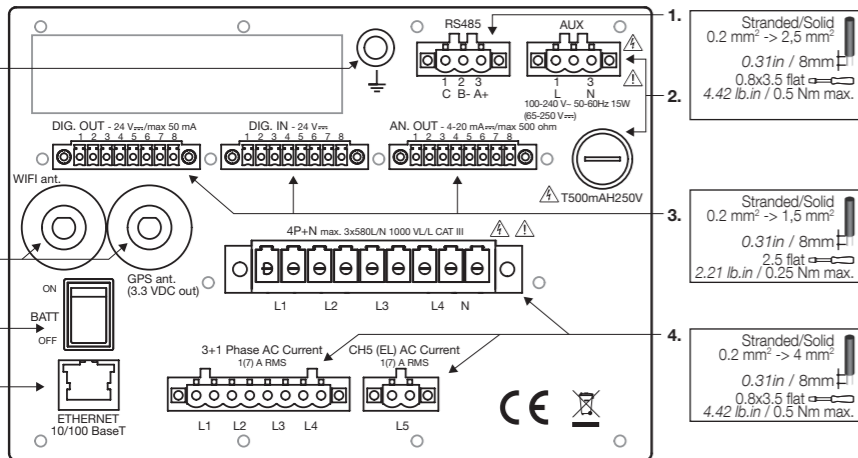

## 1. Communication via RS485 link SELV part

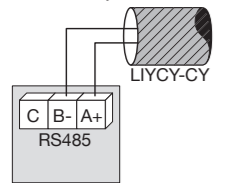

## 2. AC and DC auxiliary power supply

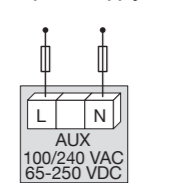

To fulfill the EMC requirements, install the included big ferrites at a maximum 5 cm distance from the device on connection cables of:

- Protective earth terminal
- Power supply terminal
- Current terminal (only CT instrument model)

Make sure the cable is wound 3 turns inside the ferrite. If the cable length is not enough, use an extension cable of at least 40 cm about. Please refer to the following picture:

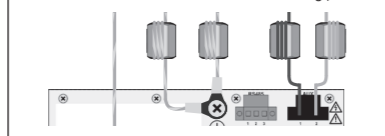

## 3. Digital / analogic outputs SELV parts (Safety extra low voltage)

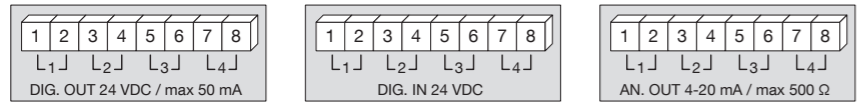

## 4. Current and voltage inputs

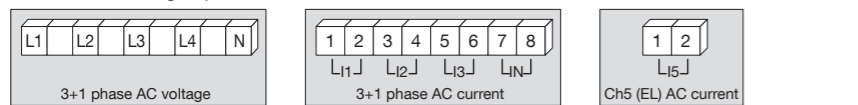

## 5. Auto MDIX Ethernet port



## 6. Battery switch

## 7. GPS and WIFI antenna

## 8. Earth connection

- Connect the grounding cable to the instrument protective earth (M6) and fix the screw with locking washer.
- For direct current applications (VDC), do not connect the protective earth to the negative pole of the power supply terminal.

# 2 Mounting

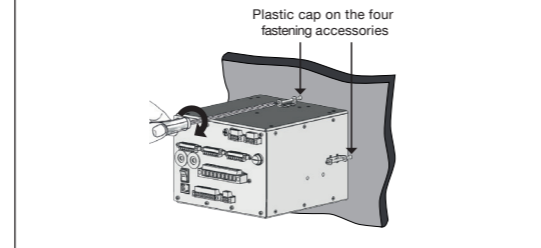
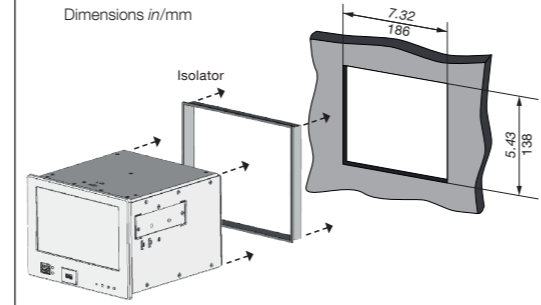

# Technical characteristics

AUXILIARY POWER SUPPLY	
Auxiliary power voltage Refer to the value indicated on the instrument	100...240 VAC 50/60 Hz / 65...250 VDC
Frequency	19...60 VDC on request
Power consumption	50/60 Hz
Backup battery	Max. 15 VA
	Li-ion 2500 mAh
MEASUREMENT INPUTS	
Direct voltage measurement input	P-N: max 580 V RMS CAT III L-L: max 1000 V RMS CAT III
U4 direct voltage measurement input	Max 580 V RMS CAT III
Voltage input crest factor	2
Current inputs	Max 7 A RMS
Current input consumption	0.04 VA
Current input crest factor	3
Voltage input impedance	> 6 MΩ
Frequency range	42.5 to 57.5 Hz/51 to 69 Hz
Voltage reference channel	U1N/U12
Sampling	51.2 kHz @50 Hz
ACCURACY	
Three-phase voltage	± 0.1%
4 <sup>th</sup> voltage (neutral/earth)	± 0.2%
Currents	± 0.2%
Power	± 0.2%
Frequency	± 10 mHz
Harmonics	Class 1 IEC/EN 61000-4-7
Active energy	Class 0.2S IEC/EN 62053-22
Reactive energy	Class 1 IEC/EN 62053-24
COMMUNICATION	
Ethernet ports	2 Auto MDIX RJ45 10/100 Base Ethernet
RS485 opto-insulated port (slave)	0.5 UL 2400 to 115200 bps
Passive WIFI antenna	SMA male connector
Active GPS antenna	SMA female connector
Protocols	HTTP, HTTPS, FTP, SFTP, NTP, NMEA, Modbus RTU/TCP, WPA, SMTP
USB port	USB 2.0
Instrument IP address	192.168.0.5
Netmask	255.255.0.0
Gateway IP address	192.168.0.1
Administrator password	Admin
ENVIRONMENTAL CONDITIONS	
Operating temperature (max. range)	- 25 °C to + 55 °C
Storage temperature	- 25 °C to + 75 °C
Humidity	Max. 95 %
Max. altitude	2000 m
STANDARDS AND SAFETY	
Product conformity	IEC/EN 62586-1, IEC/EN 62586-2
Safety	Inputs measurement CATIII Auxiliary power supply OVCIII, insulation class 2
Degree of pollution	2 (EN 61010-1)
Degree of protection	IP40 front, IP20 rear
Directive	RED §3.1a Health EN 62311 :2008 RED § 3.1b EMC
REFERENCE	
DIPIS Q800	Ref. 4826 0100 <sup>(1)</sup>

<sup>(1)</sup> Power supply 19...60 VDC; please contact us.

# 4

## 1. 0.5 A gG / 0.5 A class CC fuses.

### Direct connection : 3 phases, 4 wires, 4 CT (3.4.4)

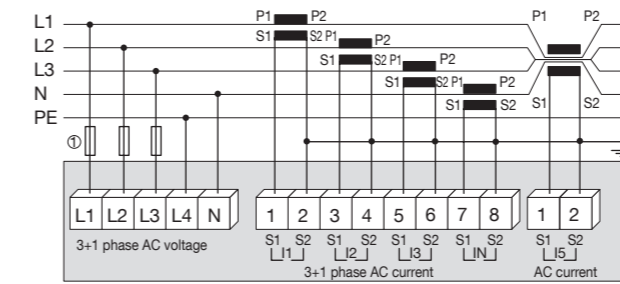

### Direct connection : 3 phases, 3 wires, 3 CT (3.3.3)

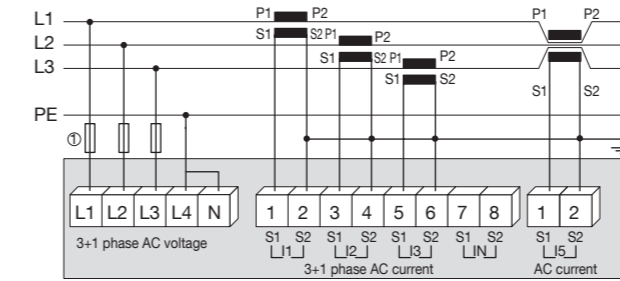

### Direct connection : 2 phases + neutral, 3 wires, 3 CT (2.3.3)

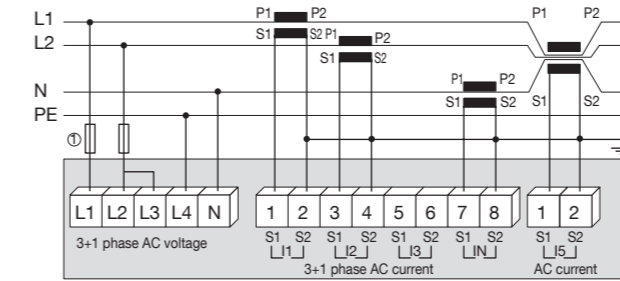

## 1. 0.5 A gG / 0.5 A class CC fuses.

### Connection with VT : 3 phases, 4 wires, 4 CT (3.4.4)

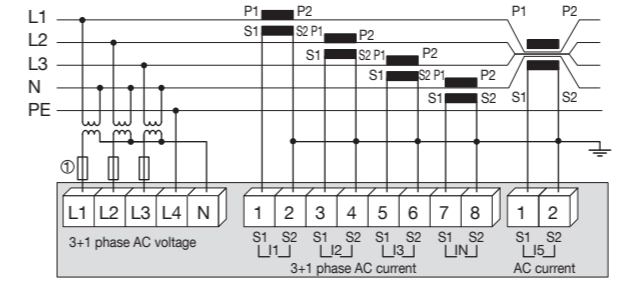

### Connection with VT : 3 phases, 3 wires, 3 CT (3.3.3)

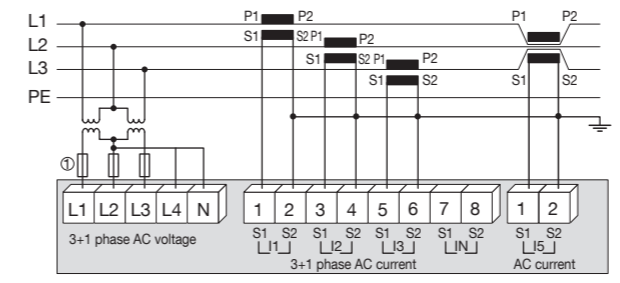

### Connection with VT : 2 phases + neutral, 3 wires, 3 CT (2.3.3)

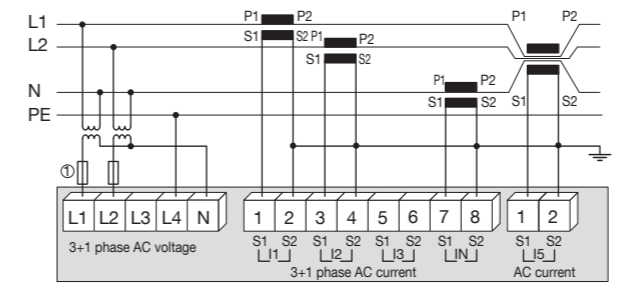

### Direct connection : 3 phases, 4 wires, 3 CT (3.4.3)

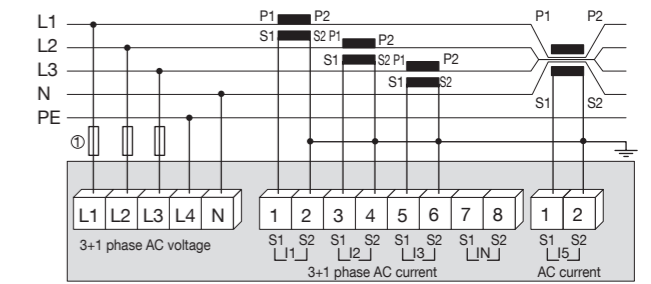

### Direct connection : 3 phases, 3 wires, 2 CT (3.3.2)

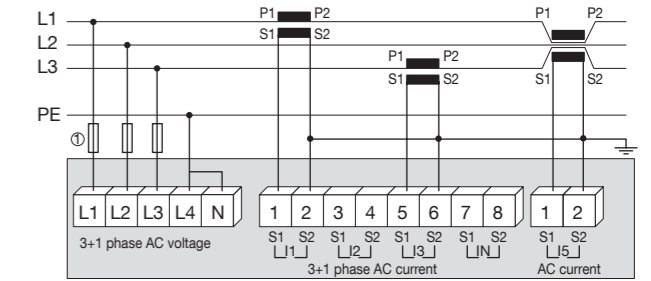

### Direct connection : 1 phase, 2 wires, 1 CT (1.2.1)

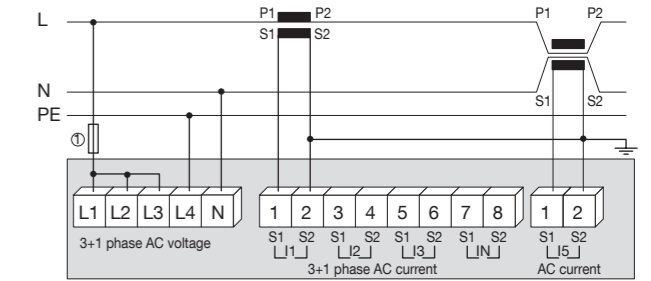

### Connection with VT : 3 phases, 4 wires, 3 CT (3.4.3)

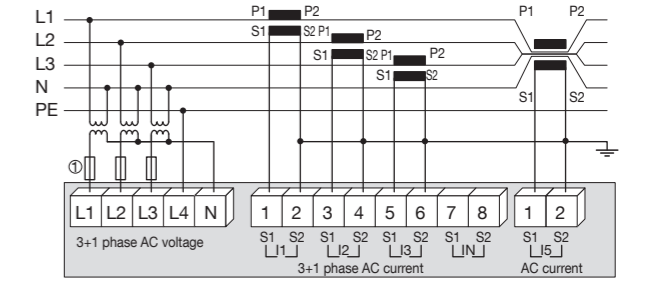

### Connection with VT : 3 phases, 3 wires, 2 CT (3.3.2)

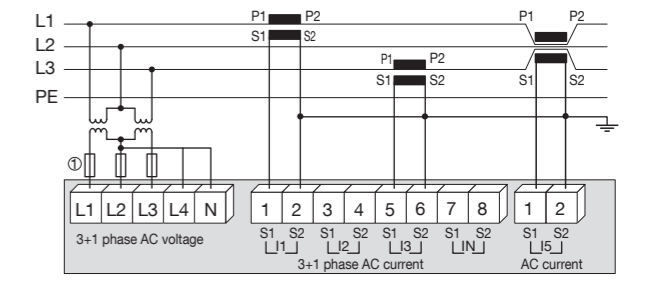

### Connection with VT : 1 phase, 2 wires, 1 CT (1.2.1)

