

INTERFACE ETHERNET

Operating instructions

GB

MAKE YOUR BUSINESS SAFE



GENERAL INFORMATION _____ **3**
 Safety _____ 3
 Maintenance _____
 Introduction _____ 4
APPROVALS AND CONFORMITY _____ **5**
 Declaration of conformity _____ 6
SPECIFICATIONS _____ **7**
 Type tests and environmental conditions _____ 7
 Interface specifications _____ 8
INSTALLATION _____ **11**
 Mounting / Removal _____ 11
 Connections _____ 12
 LED indicators _____ 14
 DIP-switch settings _____ 15
PROGRAMMATION _____ **16**
 IP address configuration _____ 16
 Getting started _____ 18
 Configuration by web tool _____ 21
APPLICATION EXAMPLES _____ **43**
 RS 485 termination _____ 43
 One to many using UDP
 broadcast or multicast _____ 43
 Point to point using TCP connection,
 server and client _____ 44
 Point to point using UDP connection _____ 44
 Communication one to many using TCP _____ 45

GENERAL INFORMATION

ETHERNET

Safety

BEFORE INSTALLATION

Read this manual completely and gather all information on the unit. Make sure that you understand it fully. Check that your application does not exceed the safe operating specifications for this unit.

This unit should only be installed by qualified personnel. This unit should be built-in to an apparatus cabinet, or similar, where access is restricted to service personnel only.

The power supply wiring must be sufficiently fused, and if necessary it must be possible to disconnect manually from the power supply. Ensure compliance to national installation regulations.

This unit uses convection cooling. To avoid obstructing the airflow around the unit, follow the spacing recommendations (see Cooling section).

BEFORE MOUNTING, USING OR REMOVING THIS UNIT

Prevent access to hazardous voltage by disconnecting the unit from power supply and all other electrical connections.



Do not open connected unit. Hazardous voltage may occur within this unit when connected to power supply or TNV circuits.

Maintenance

No maintenance is required, as long as the unit is used as intended within the specified conditions.

GENERAL INFORMATION

ETHERNET

Introduction

The interface ETHERNET/ RS232-RS485 is an Industrial Ethernet to serial adapter or Ethernet Terminal Server.

The serial interface is selectable between RS232 and RS485. The Ethernet interface is 10/100BASE-T and supports the following networking protocols: TCP, UDP, ICMP, IGMP, HTTP, ARP.

Two converters can be used to provide a serial point to point link over an Ethernet network using either UDP or TCP. When using TCP the interface can be configured as client or server.

Each unit passes data from its serial interface to the serial interface of the other unit.

This enables long distance serial communication using pre-existing networks.

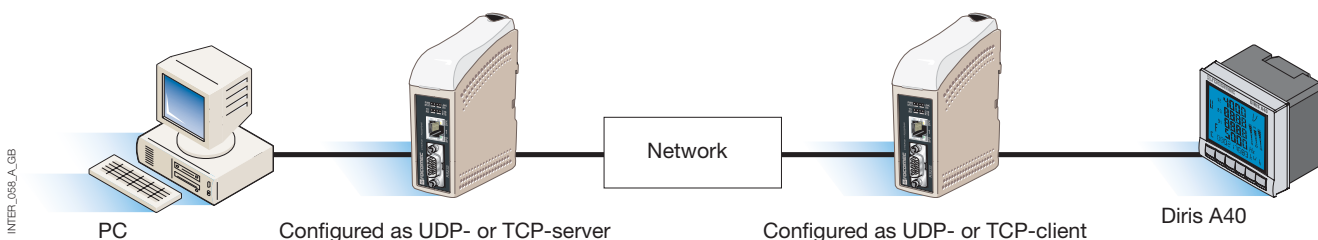

When the interface ETHERNET/ RS232-RS485 is used with the UDP protocol it is also possible to communi-

cate one to many (e.g. master to multiple slaves), by using a broadcast address or multicast addressing.

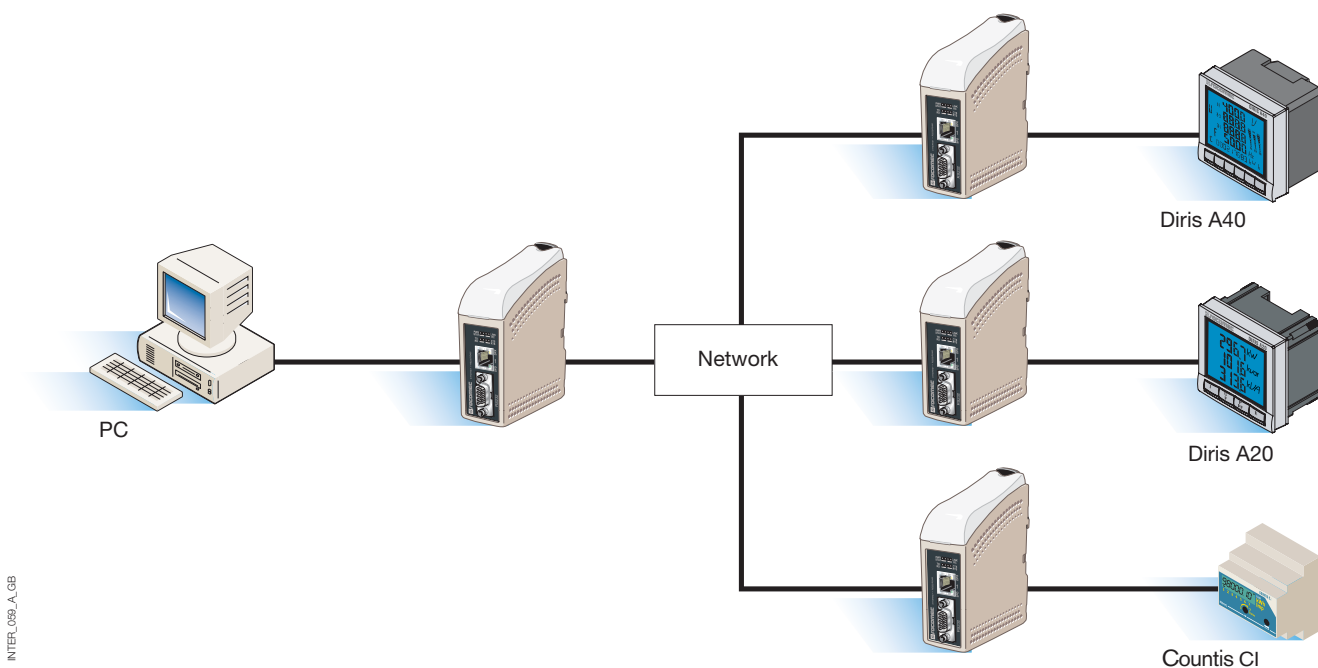

For more information on applications and technical data visit www.socomec.com.

The Web tool also includes an integrated help where all functions and modes are described in details.

Link to ETHERNET / RS232-RS485 help on the CD: Explore the Web-tool

APPROVALS AND CONFORMITY

ETHERNET

Type	Approval / Compliance
EMC	EN 61000-6-2, Immunity industrial environments EN 61000-6-4, Emission industrial environments EN 55024, Immunity IT equipment EN 50121-4, Railway signalling and telecommunications apparatus IEC 62236-4, Railway signalling and telecommunications apparatus
Safety	EN 60950, IT equipment

APPROVALS AND CONFORMITY

ETHERNET

Declaration of conformity



On-load industrial switches and UPS systems

Testing laboratory
rue de Westhouse
B.P. 10
67235 BENFELD Cedex
Tel. (33) 03 88 57 41 41 - Telex 870 844
Fax (33) 03 88 57 42 20

ATTESTATION OF CONFORMITY CE No AC 9852 PRO

Following specifications :
Manufacturer's specifications

TESTED MATERIAL

Designation : System ensuring the control, management and protection of electrical networks
Type : Ethernet communication gateway
Reference : 4899 0300
Manufacturer : SOCOMEC S.A. 67230 BENFELD FRANCE

Rated characteristics :

The above-mentioned materials,

-subject to installation, maintenance and use according to its intended purpose, to its regulations, to the standards in force and to the manufacturer's instructions and rules-

Satisfy to the European Low voltage directive n° 73/23/CEE dated 19/02/73 modified by the directive n° 93/68/CEE dated 22/07/93,

and to the European EMC directive n° 89/336/CEE dated 03/05/89 modified by the directive n° 92/31/CEE dated 28/04/92 modified by the directive n° 93/68/CEE dated 22/07/93

and to the EN 61000-6-2(2001) ; EN 61000-6-1(2001) ; EN 55024(1998) ; EN 61000-6-3(2001) ; EN 60950(2000)

Year of the CE mark apposition : 2006

Date : October 17th , 2006

The Writer

Nadine METZ



Test, Standard and Certification
Manager

Dominique MARBACH

socomec s.a. au capital de 11 406 652 € - r.c.s. strasbourg B 548 500 149 - siret 548 500 149 00016 - c.c.p. strasbourg 7180 p
siège social : 1-4, rue de Westhouse - boîte postale 10 - 67230 benfeld france - tél. 03 88 57 41 41 - télécopie 03 88 57 78 78 - Site Web :
www.socomec.fr

PCD 03 010585

Archivage : 10 ans par SCP-LAB

SPECIFICATIONS

ETHERNET

Type tests and environmental conditions

ELECTROMAGNETIC COMPATIBILITY

Phenomena	Test	Description	Test levels
ESD	EN 61000-4-2	Enclosure contact Enclosure air	± 6 kV ± 8 kV
RF field AM modulated	IEC 61000-4-3	Enclosure	10 V/m 80% AM (1 kHz), 80 – 1 000 MHz 20 V/m 80% AM (1 kHz), 800 – 960 MHz 20 V/m 80% AM (1 kHz), 1 400 – 2 000 MHz
RF field 900 MHz	ENV 50204	Enclosure	20 V/m pulse modulated 200 Hz, 900 ± 5 MHz
Fast transient	EN 61000-4-4	Signal ports Power ports	± 2 kV ± 2 kV
Surge	EN 61000-4-5	Signal ports unbalanced Signal ports balanced Power ports	± 2 kV line to earth, ± 2 kV line to line ± 2 kV line to earth, ± 1 kV line to line ± 2 kV line to earth, ± 2 kV line to line
RF conducted	EN 61000-4-6	Signal ports Power ports	10 V 80% AM (1 kHz), 0.15 – 80 MHz 10 V 80% AM (1 kHz), 0.15 – 80 MHz
Power frequency magnetic field	EN 61000-4-8	Enclosure	100 A/m, 50 Hz, 16.7 Hz & 0 Hz
Pulse magnetic field	EN 61000-4-9	Enclosure	100 A/m, 6.4 / 16 ms pulse
Voltage dips and interruption	EN 61000-4-11	AC power ports	10 & 5 000 ms, interruption 10 & 500 ms, 30% reduction 100 & 1 000 ms, 60% reduction
Radiated emission	EN 55022	Enclosure	Class A
Conducted emission	EN 55022 EN 55022	AC power ports DC power ports	Class B Class B
Dielectric strength	EN 60950	Signal port to other isolated ports	2 kVrms 50 Hz 1 min
		Power port to other isolated ports	3 kVrms 50 Hz 1 min 2 kVrms 50 Hz 1 min (@ rated power <60 V)

ENVIRONMENTAL

Phenomena	Test	Description	Level
Temperature		Operating Storage & Transport	-25 to +70°C -40 to +70°C
Humidity		Operating Storage & Transport	5 to 95% relative humidity 5 to 95% relative humidity
Altitude		Operating	2 000 m / 70 kPa
Service life		Operating	10 year
Vibration	IEC 60068-2-6	Operating	7.5 mm, 5 – 8 Hz 2 g, 8 – 500 Hz
Shock	IEC 60068-2-27	Operating	15 g, 11 ms

SPECIFICATIONS

ETHERNET

Type tests and environmental conditions

PACKAGING

Enclosure	UL 94	PC / ABS	Flammability class V-1
Dimension W x H x D			35 x 121 x 121 mm
Weight			0.2 kg
Degree of protection	IEC 529	Enclosure	IP 21
Cooling			Convection
Mounting			On 35 mm DIN-rail

Interface specifications

POWER

Rated voltage	12 to 48 VDC
Operating voltage	10 to 60 VDC
Rated current	250 mA @ 12 VDC 125 mA @ 24 VDC 63 mA @ 48 VDC
Rated frequency	DC
Maximum inrush current @ 10 ms	0.3 A ² s @ 48 VDC
Polarity	Reverse polarity protected
Redundant power input	Yes
Isolation to	All other 3 k Vrms
Connection	Detachable screw terminal
Connector size	0.2 – 2.5 mm ² (AWG 24 – 12)

Interface specifications

RS485

Electrical specification	EIA RS485 2-wire twisted pair
Data rate	300 bit/s – 115.2 kbit/s
Data format	7 or 8 data bits, Odd, even or none parity, 1 or 2 stop bits
Protocol	Transparent, optimised by packing algorithm
Retiming	Not applicable
Turn around time	< 3 bits
Circuit type	TNV-1
Transmission range	≤ 1200 m, depending on data rate and cable type (EIA RS485)
Settings	120 Ω termination and fail-safe biasing 680 Ω
Protection	Installation Fault Tolerant (up to ±60 V)
Isolation to	Power 3 kV Ethernet 1 1.5 k Vrms
Connection	Detachable screw terminal
Connector size	0.2 – 2.5 mm ² (AWG 24 – 12)
Shielded cable	See “RS485 single bus implementation and repairs” manual
Conductive housing	No

SPECIFICATIONS

ETHERNET

Interface specifications

RS232

Electrical specification	EIA RS232
Data rate	300 bit/s – 115.2 kbit/s
Data format	7 or 8 data bits, Odd, even or none parity, 1 or 2 stop bits.
Protocol	Transparent, optimised by packing algorithm
Retiming	Not applicable
Circuit type	SELV
Transmission range	15 m
Isolation to	Power 3kV Ethernet 1 1.5 kVrms
Connection	9-pin D-sub male (DTE)
Shielded cable	Not required, except when installed in Railway applications as signalling and telecommunications apparatus and located close to rails*
Conductive housing	Isolated to all other circuits
Number of ports	1

ETHERNET

Electrical specification	IEEE std 802.3. 2000 Edition
Data rate	10 Mbit/s or 100 Mbit/s, auto-negotiated or manually set by DIP-switches
Protocol	UDP, TCP, ICMP, HTTP and ARP
Duplex	Full- or half duplex, auto-negotiated or manually set by DIP-switches
Circuit type	TNV-1
Transmission range	100 m
Isolation to	Power 3 k Vrms RS232 1.5 k Vrms RS485 1.5 k Vrms
Connection	RJ-45 shielded, auto MDI/MDI-X
Shielded cable	Not required, except when installed in Railway applications as signalling and telecommunications apparatus and located close to rails*
Conductive housing	Isolated to all other circuits

* To minimise the risk of interference, a shielded cable is recommended when the cable is located inside 3 m boundary to the rails and connected to this port.

The cable shield should be properly connected (360°) to an earthing point within 1 m from this port.

This earthing point should have a low impedance connection to the conductive enclosure of the apparatus cabinet, or similar, where the unit is built-in. This conductive enclosure should be connected to the earthing system of an installation and may be directly connected to the protective earth.

INSTALLATION

ETHERNET

Mounting/Removal

This unit should be mounted on 35 mm DIN-rail, which is horizontally mounted inside an apparatus cabinet, or similar.

Snap on mounting, see figure.

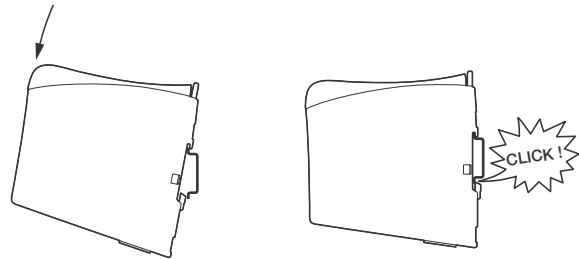

INTER_037_A

COOLING

This unit uses convection cooling. To avoid obstructing the airflow around the unit, use the following spacing rules. Minimum spacing 25 mm (1.0 inch) above /below and 10 mm (0.4 inches) left /right the unit. Spacing is recommended for the use of unit in full operating temperature range and service life.

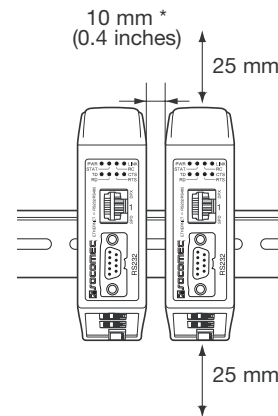

INTER_061_A

* Spacing (left/right) recommended for full operating temperature range

REMOVAL

Press down the black support at the top of the unit. See figure.

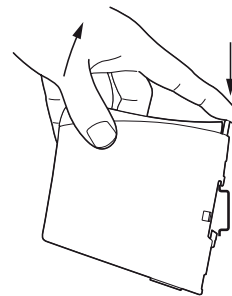

INTER_037_A

INSTALLATION

ETHERNET

Connections

> RS232 (DTE)

Pin	Direction	Description*
1	N/C	Not connected (DCD)
2	In	Received Data (RD)
3	Out	Transmitted Data (TD)
4	Out	Data Terminal Ready (DTR)
5	-	Signal Ground (SG)
6	In	Data Set Ready (DSR)
7	Out	Request To Send (RTS)
8	In	Clear To Send (CTS)
9	N/C	Not connected (RI)

* Direction relative this unit.

> RS485 interface screw terminal

Pin	Direction	Description
3	In/Out	T- : Line RS485
4	In/Out	T+ : Line RS485

> Power connection screw terminal

Pin	Description
1	Commun
2	+VA
3	+VB
4	Commun

The interface supports redundant power connection. The positive input are +VA and +VB, the negative input for both supplies are COM. The power is drawn from the input with the highest voltage.

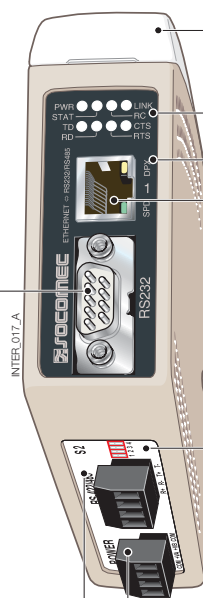

S1 DIP-switch under lid
(for détails see page 15)

LED indicators, also integrated
in the RJ-45 connector
(for détails see page 14)

Ethernet 1 RJ-45 connection
(for détails see page 13)

S2 DIP switch - Termination
(for détails see page 15)

Connections

ETHERNET

Ethernet TX connection (RJ-45 connector), automatic MDI/MDI-X crossover*.

Contact	Signal	Name	Direction	Description/Remark
1	TD+	In/Out		Transmitted/Received data
2	TD-	In/Out		Transmitted/Received data
3	RD+	In/Out		Transmitted/Received data
4				NC
5				NC
6	RD-	In/Out		Transmitted/Received data
7				NC
8				NC
Shield				HF-connected

* Depend of settings on S1; 6, 7 and 8.

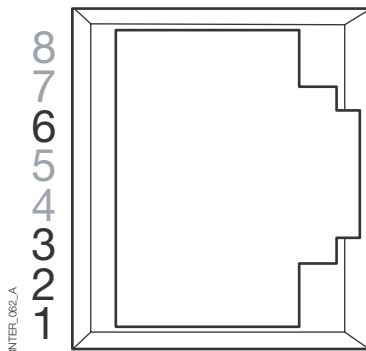

CAT 5 cable is recommended.

Unshielded (UTP) or shielded (STP) connector might be used.

INSTALLATION

ETHERNET

LED Indicators

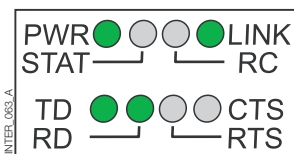

LED	Status	Description
PWR Power	OFF ON	No internal power Internal Power OK
TD Transmit data	OFF ON	No serial data transmitted from the unit, (RS232 or RS485) Serial data transmitted from the unit, (RS232 or RS485)
RD Receive data	OFF ON	No serial data received to the unit, (RS232 or RS485) Serial data received to the unit, (RS232 or RS485)
RTS Request to send	OFF ON	No RTS to the RS232 interface or RS485 transmitting. RTS to the RS232 interface or RS485 receiving.
CTS Clear to send	OFF ON	No CTS from the RS232 interface CTS from the RS232 interface
LINK	OFF ON Flash	No Ethernet link. Cable not connected. Good Ethernet link. Ethernet data is transmitted or received, traffic indication.
STAT Status	OFF ON	Normally Off Telnet session established to Telnet diagnostics service or Ongoing configuration by Web tool
RC Remotely controlled	OFF ON	DIP switch settings are valid. One or more DIP switches are overrid by remote configuration
SPD Speed Integrated in RJ-45 - Green	ON OFF	Ethernet 100 Mbit/s Ethernet 10 Mbit/s
DPX Duplex Integrated in RJ-45 - Yellow	ON OFF	Full duplex Half duplex

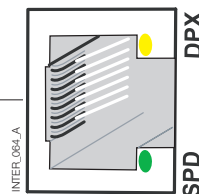

DIP-switch settings

BEFORE DIP-SWITCH SETTINGS:

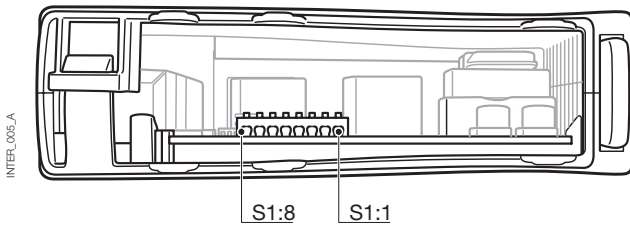

! Prevent damage to internal electronics from electrostatic discharges (ESD) by discharging your body to a grounding point (e.g. use of wrist strap).

> S1*

DIP-switch



Normally OFF.

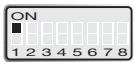

Enable local IP configure via serial interface.



Normally OFF.



Restore factory default.



Ethernet Auto-negotiation enabled.
Auto-crossover enabled. 10 Mbit/s.

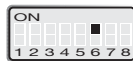

Ethernet Auto-negotiation disabled.
Auto crossover (MDI/MDIX) disabled. 10 Mbit/s.

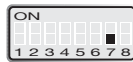

Ethernet 100 Mbit/s when Autonegotiation disabled.

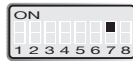

Ethernet 10 Mbit/s when Autonegotiation disabled

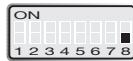

Ethernet Half Duplex Auto-negotiation disabled or is not supported.

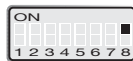

Ethernet Full duplex when Autonegotiation disabled or is not supported.

* DIP switch functions may be override by WEB configuration tool. Override is indicated by RC LED.
S1, 3, 4 and 5 not used.

Note: DIP-switch alterations are only effective after a power on. A setting configured by any other method during normal operation, possibly overrides the DIP-switch setting. However, an override situation is indicated by the RC LED.

> S2

Below panel



2-wire termination. 120 ohm 2-wire termination and fail-safe

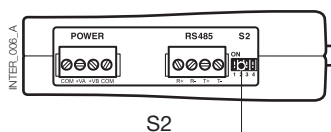

Factory settings



S1



S2

PROGRAMMATION

ETHERNET

The interface ETHERNET/RS232-RS485 is an industrial Ethernet to serial interface adapter designed for harsh environments.

It allows serial devices to interface through a new or existing Ethernet network. The unit can support either RS232 or RS485 based protocols running at up to 115.2 kbit/s. Ethernet connection is via a standard RJ-45 port with MDI/MDI-X.

The protocols used for network communication is UDP or TCP. This allows the interface to be setup as a TCP-server or -client as well as an UDP unit.

IP Adress configuration

The converter can be easily configured via the onboard Web based configuration tool, alternatively some functions can also be set by hardware DIP-switches on the PCB.

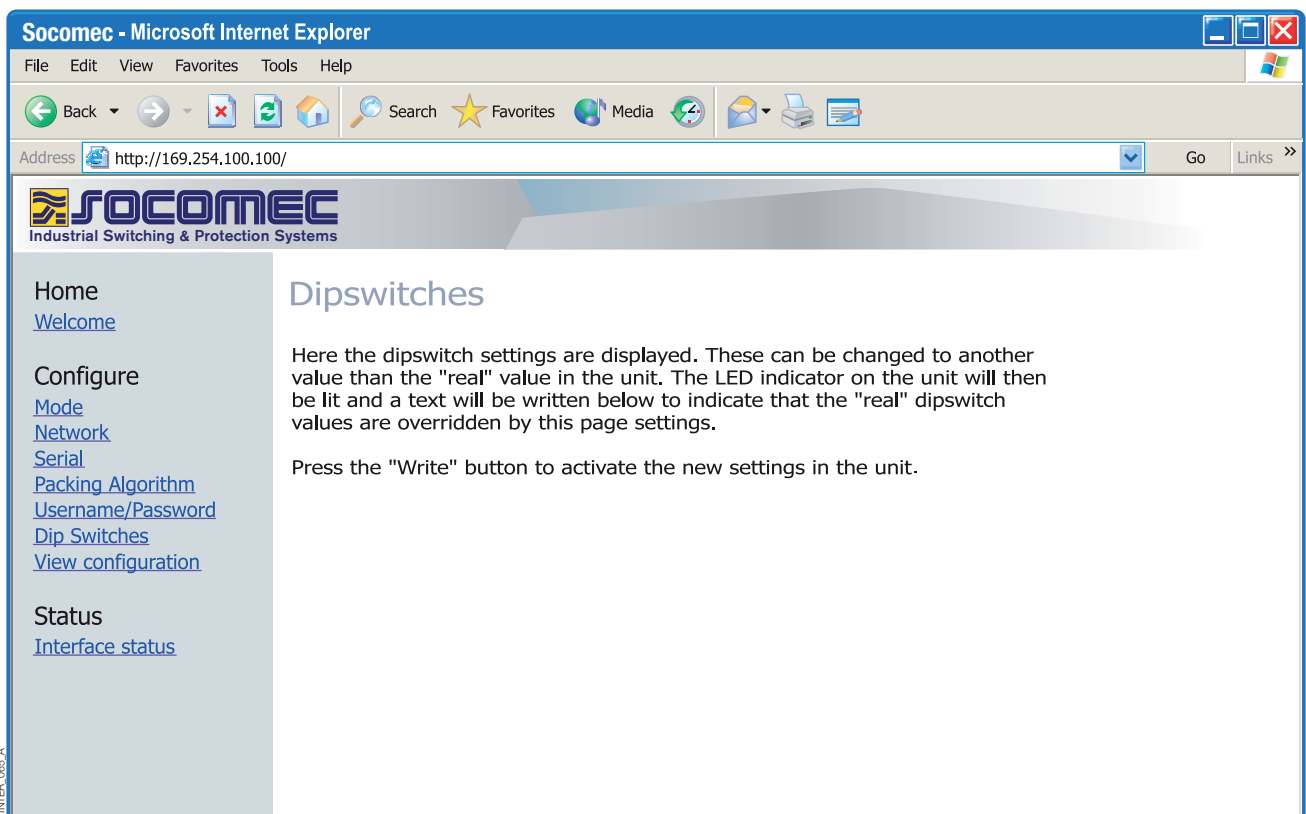

The network interface properties such as speed, duplex and auto-negotiation can be configured by the Web based configuration tool or by hardware DIP-switches.

It is also possible to monitor and override the hardware settings by using the Web tool, if that is done this is indicated by the RC LED (Remotely Controlled).

The serial port properties such as data rate, flow control and data bits etc. are configured by the Web based configuration tool.

IP Adress configuration

Termination and fail-safe of the RS485 serial interface can only be made by DIP-switches only.

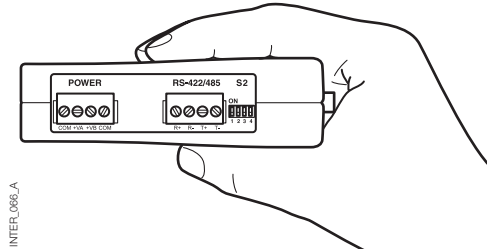

The local IP address of the unit can be configured by using a terminal program.

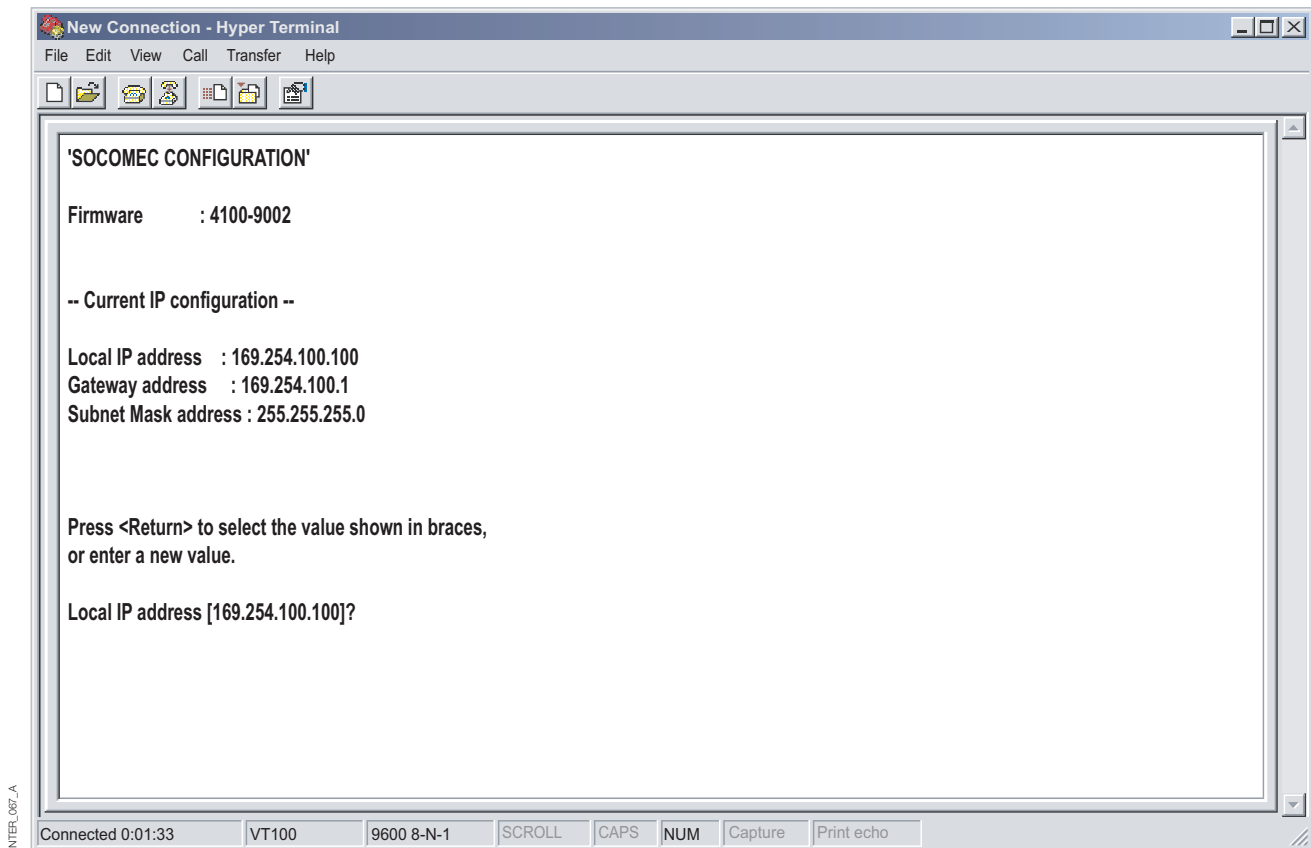

UNIQUE FEATURES

- Packing algorithm that enables the user to decide how and when the serial data should be encapsulated in a TCP or UDP data frame and sent out on the network.
- Galvanic isolation, this feature eliminates communication errors. One of the most common errors is caused by potential differences between interconnected equipment.
- Redundant power supply with wide input range.

These features along with the high EMC immunity enables the device to be used in projects where a high degree of reliability is required.

PROGRAMMATION

ETHERNET

IP Adress configuration

DIAGNOSTIC INFORMATION

The first level of diagnostic information is the status indicated by the LED's.

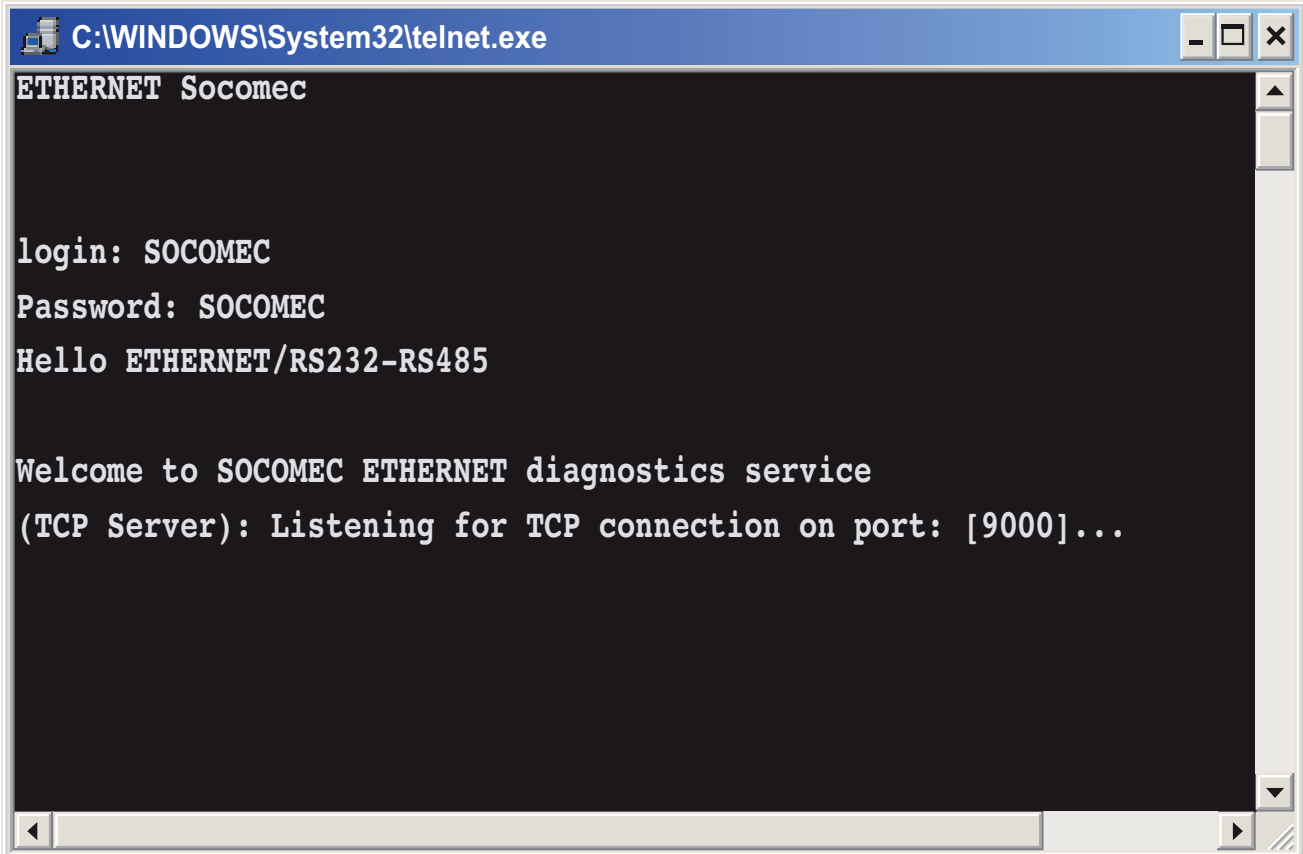

The screenshot shows a Windows command prompt window titled "C:\WINDOWS\System32\telnet.exe". The window content displays the following text:

```
ETHERNET Socomec

login: SOCOMEc
Password: SOCOMEc
Hello ETHERNET/RS232-RS485

Welcome to SOCOMEc ETHERNET diagnostics service
(TCP Server): Listening for TCP connection on port: [9000]...
```

The Telnet diagnostic service provide the user with information such as UDP- or TCP mode, connected or listening state (TCP) etc.

Getting started

> IP Address

The default IP address of the interface ETHERNET when delivered is 169.254.100.100.

Default port 9000

Default gateway 169.254.100.1

Getting started

> IP address configuration

The IP address is configurable by the Web tool and/or by using a terminal program.

Below is a description of how to configure the IP address by using a terminal program.

1. If the address is known, connect the unit from a Web browser with the address to the interface. If the address is unknown, connect the serial RS232 interface to a terminal program with settings:

Data rate: 9600 bit/s
Data bits: 8
Stop bits: 1
Parity: None
Flow control: None

INTER_138_A_GB

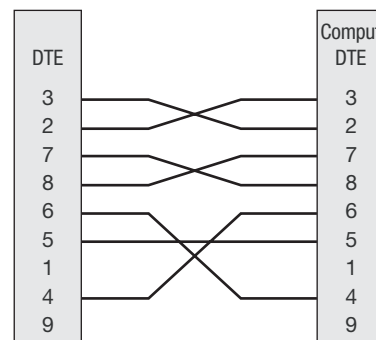

2. Setting DIP S1:1 to 'On' and power-up the interface will enable the local IP address to be configured via serial interface.

Once connected with the terminal program you can change the IP address, Gateway address and Subnet Mask according to the picture below:

See also configuration by Web tool on page 21.

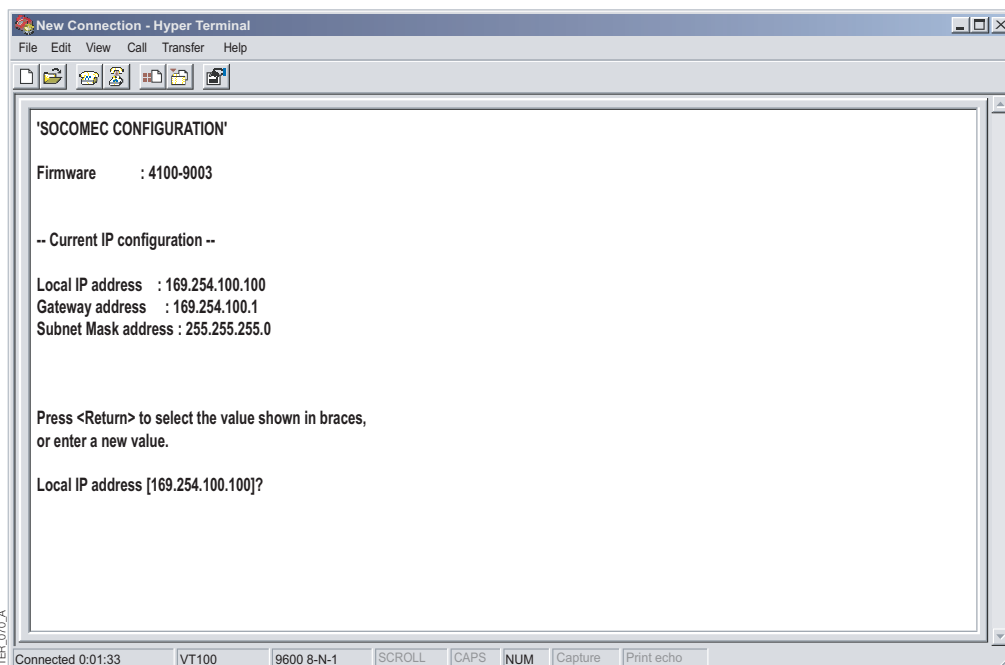

3. Set DIP S1:1 to 'Off' and power cycle the interface.

4. The unit is now ready for a complete configuration by the Web tool. Address converter in a browser with the configured IP address.

PROGRAMMATION

ETHERNET

Getting started

> Username and Password for configuration

The interface ETHERNET/RS232-RS485 is username and password protected. These are used when connecting with Web browser during configuration and with Telnet for diagnostics.

Default username: SOCOMEC

Default password: SOCOMEC

> Browser Login

The Webtool has two different login accounts.

The first is the interface Guest account that only allows the user to read the units settings but he has no rights to

configure the unit in any way. This accounts Username and Password are fixed and aren't configurable.

> Interface ETHERNET/RS232-RS485 Guest (only visualization)

Username: guest

Password: guest

or

Username: anonymous

Password: anonymous

> Interface ETHERNET/RS232-RS485 Config

The second account is the converter Config that gives the user rights to configure the unit with new parameter values. This accounts Username and Password can also be configured when the user are logged in as converter Config. Default Username and Password are listed below.

Default Username: SOCOMEC

Default Password: SOCOMEC

> Restore Factory default settings



Note: This will clear your customized settings. The factory default settings can be restored using DIP-switch S1:2.

1. Force this to 'On' and Power-up the interface for at least 5 seconds.

2. Force the DIP-switch to 'Off' and power cycle the interface.

The product now contains the factory default settings.

Note: If the default address of the unit is valid on the connected network it is possible to access the unit directly from a browser.

Configuration by Web tool

The interface includes an easy-to-use Web configuration tool. The Web tool is very intuitive and includes useful help information for the configurable parameters.

Connect and login to the interface with the converter Config account on the default IP address and with default username- and password combination (or your customized if configured) using a standard Web browser.

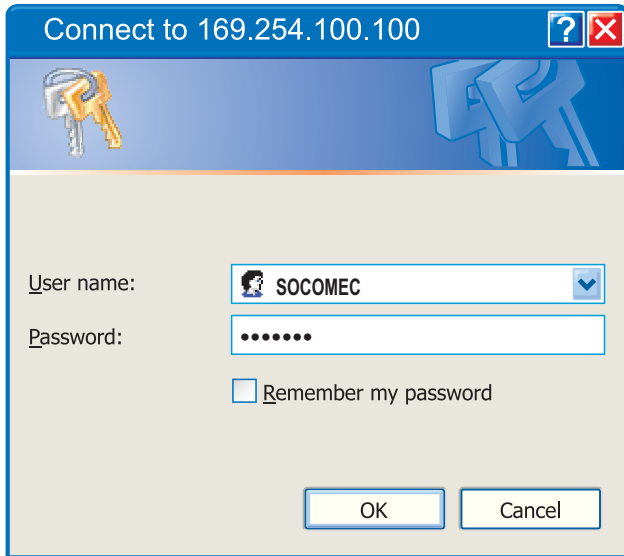

Use the Configuration Wizard to set all parameters then press the button "Program Unit" to write the parameters into the unit or save the parameters to a file.

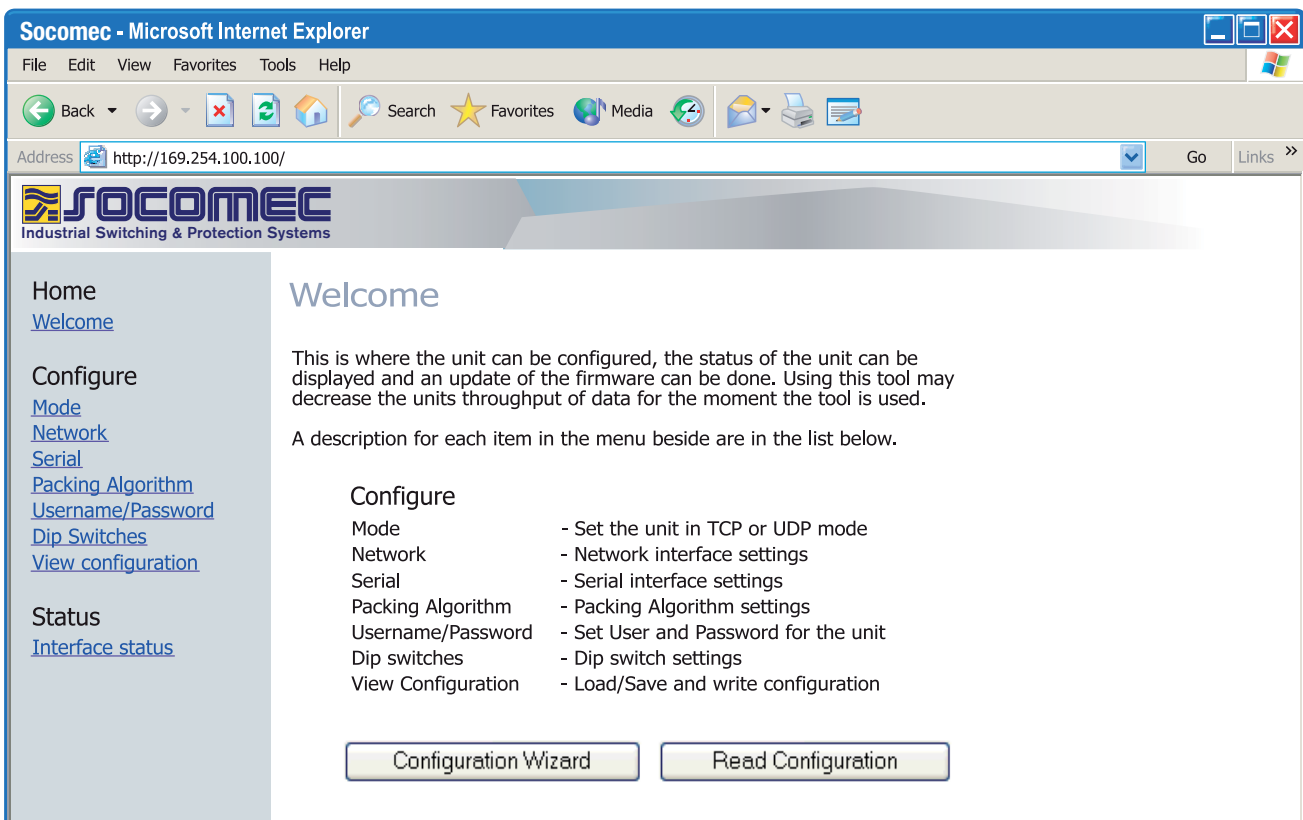

PROGRAMMATION

ETHERNET

Configuration by Web tool

DIAGNOSTICS VIA TELNET

The interface provides the user with diagnostics information via a Telnet connection on port 23.

Information presented to the user is:

- Operational mode (UDP, TCP-server or client)
- Operational status (Listening for connection (TCP server), connected to host (TCP server or client), Attempting to connect (TCP client))
- The 'Status' LED on the product will lit during Telnet session.

Below is a description of how to start a Windows Telnet session and get diagnostics information from the converter.

1. Start a Telnet session.
2. Connect to interface by typing 'o 169.254.100.100' or the configured IP address of the interface.
3. Login using default username and password (or your customized settings if configured).

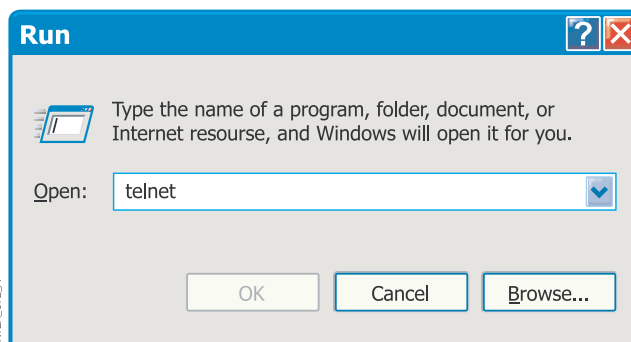

INTER.072.A

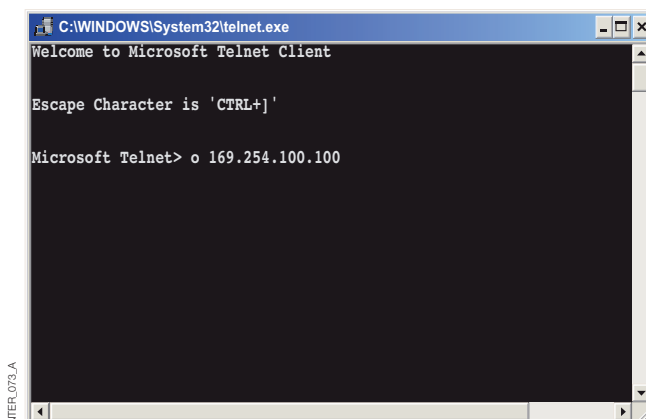

INTER.073.A

APPLICATION MODES

The product can be setup for use in one of three different application modes:

- TCP Server
- TCP Client
- UDP

Configuration by Web tool

SHORT DESCRIPTION OF TCP AND UDP

> User Datagram Protocol (UDP)

UDP provides a connectionless datagram service. This means that the arrival of datagram's or data packets is not controlled and the reliability of the communication is the responsibility of the application layer protocol. In this way UDP is a simpler method of communication

than TCP. As data is sent and received without any established connection the data transfer is more efficient and often faster. UDP is therefore used in applications that require efficient use of the bandwidth and also have a higher level protocol to handle lost data.

> Transmission Control Protocol (TCP)

TCP is a connection-oriented delivery service. Connection oriented means that a connection must be established before hosts can exchange data. An acknowledgement is used to verify that the data was received by the other host. For data segments sent, the receiving host must return an acknowledgement (ACK). If an ACK is not received, the data is retransmitted. Flow-control between the hosts is managed by TCP. For larger

amounts of data that have to be split between packets TCP provides a method for reliably reassembling the data in the correct order. Because of the requirement to establish a connection and acknowledge transmissions, TCP takes longer time to transmit data than UDP and uses more bandwidth.

When delivered the interface is in TCP server mode.

> TCP Server mode

This mode makes it possible to accept incoming TCP connections attempts to the interface from an TCP client e.g. a interface in TCP client mode. Other examples of TCP

clients: Telnet client establishing a raw TCP connection, COM-port redirector software running on a Windows PC.

> TCP Client mode

This mode makes it possible to establish a TCP connection to a remote TCP server e.g. a product in TCP Server mode. DSR signal rising or a powering up the unit will trigger the

interface to make an connection attempt to the specified server depending on configuration.

> UDP mode

UDP is a connection less protocol sending datagram's i.e. there are less overhead traffic compared to TCP and no acknowledgement packets will be sent between the peer's during communication.

Using UDP will enable the converter to send and listen to broadcast- and multicast messages.

PROGRAMMATION

ETHERNET

Configuration by Web tool

PACKING ALGORITHM

When data arrives at the serial port of the interface there must be one or more criteria fulfilled to trigger the converter to encapsulate the received serial data into a frame and send it out on the network.

These criteria are setup using different parameters i.e. the 'packing algorithm'. The default settings are selected to be compatible to most applications but can be optimized to

the customer specific application. Detailed description can be received from the Web configuration tool. Link to interface ETHERNET /RS232-RS485 help on the CD:

Please click here (\Software\interface ETHERNET /RS232-RS485Webtool\ files\helpfiles\packing_help.html).

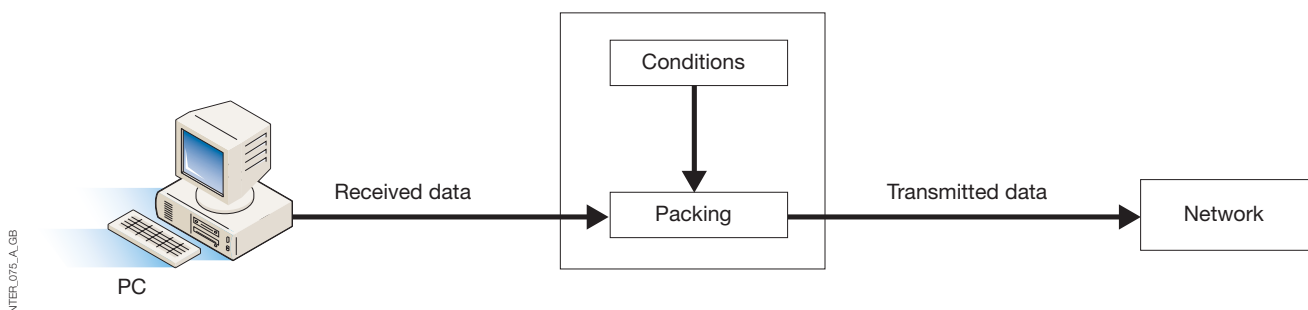

ADVANCED SETTINGS

Advanced settings configure the unit for special application requirements or special interface functions, these settings are default disabled.

Detailed description can be received from the Web configuration tool. Link to interface ETHERNET /RS232-RS485 help on the CD:

Please click here (\Software\interface ETHERNET /RS232-RS485Webtool\files\helpfiles\advanced_help.html).

Configuration by Web tool

CLIENT GATEWAY CONFIGURATION

> Client Gateway

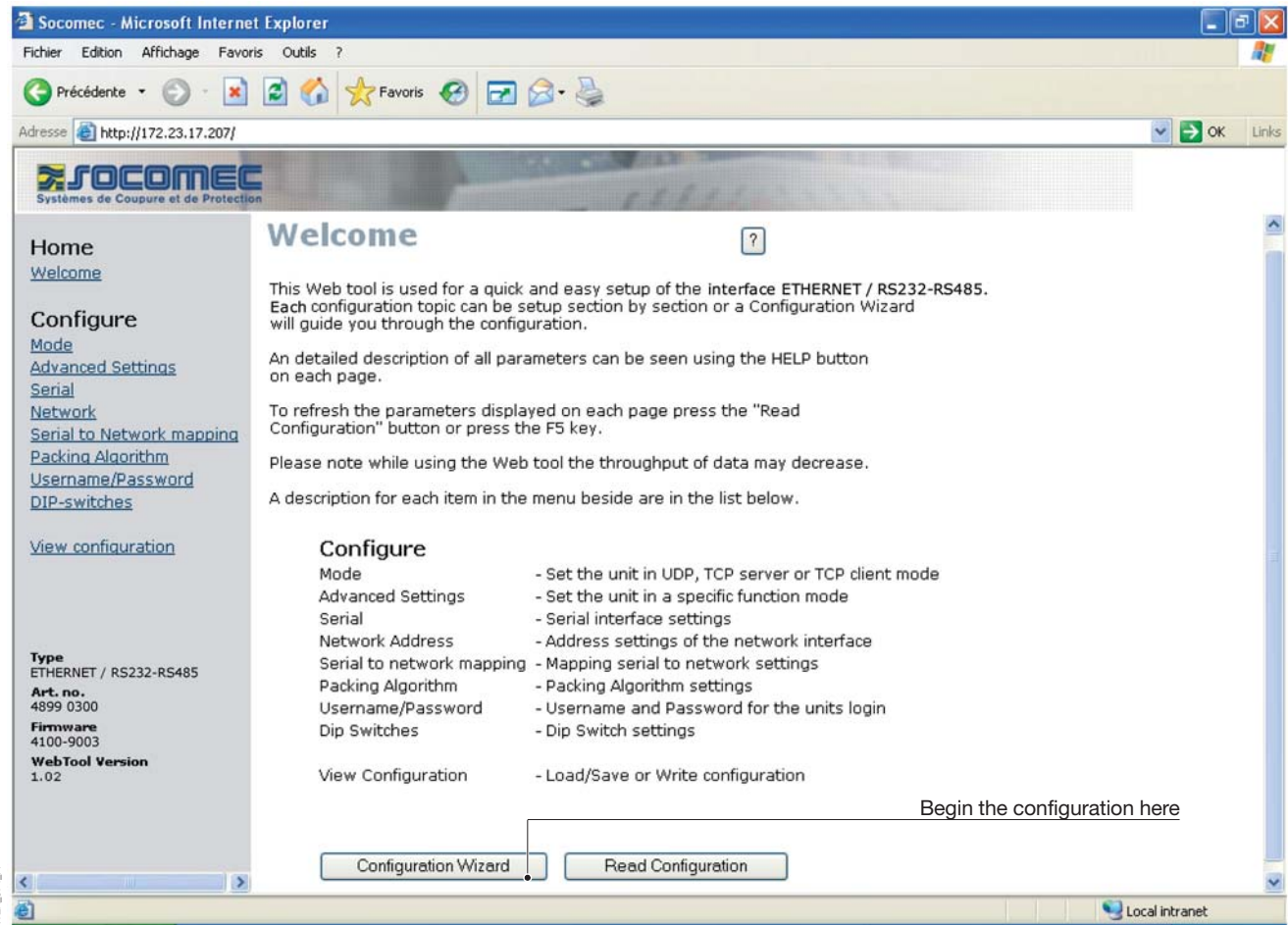

INTER_074_A

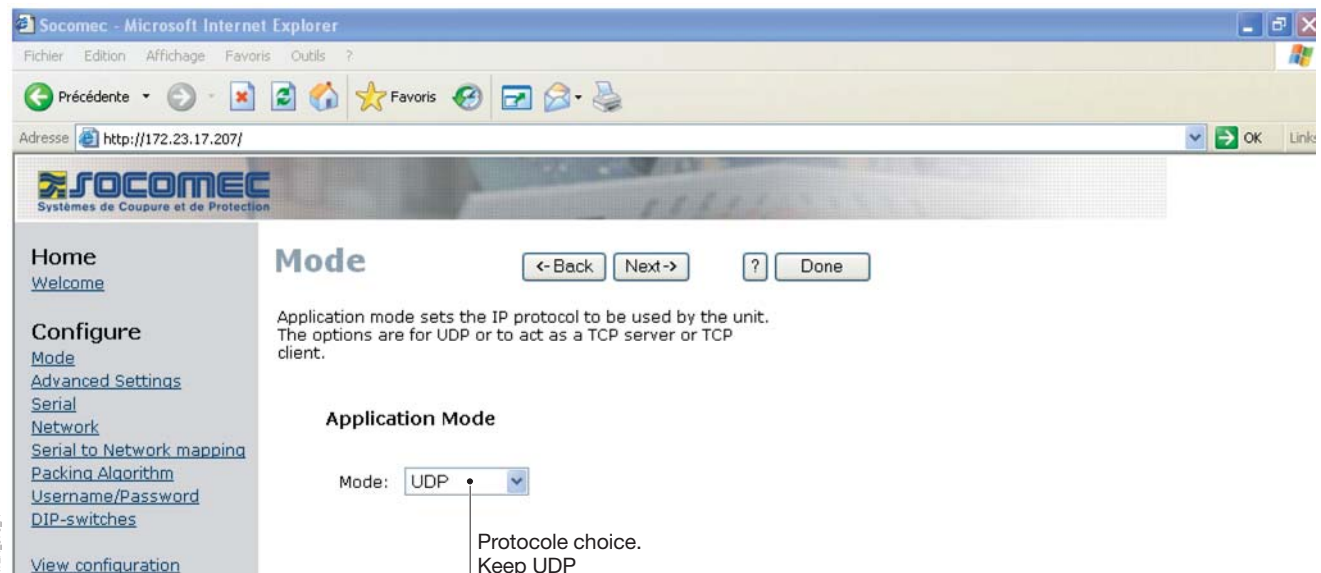

INTER_076_A

PROGRAMMATION **ETHERNET**

Configuration by Web tool

CLIENT GATEWAY CONFIGURATION

> Client Gateway

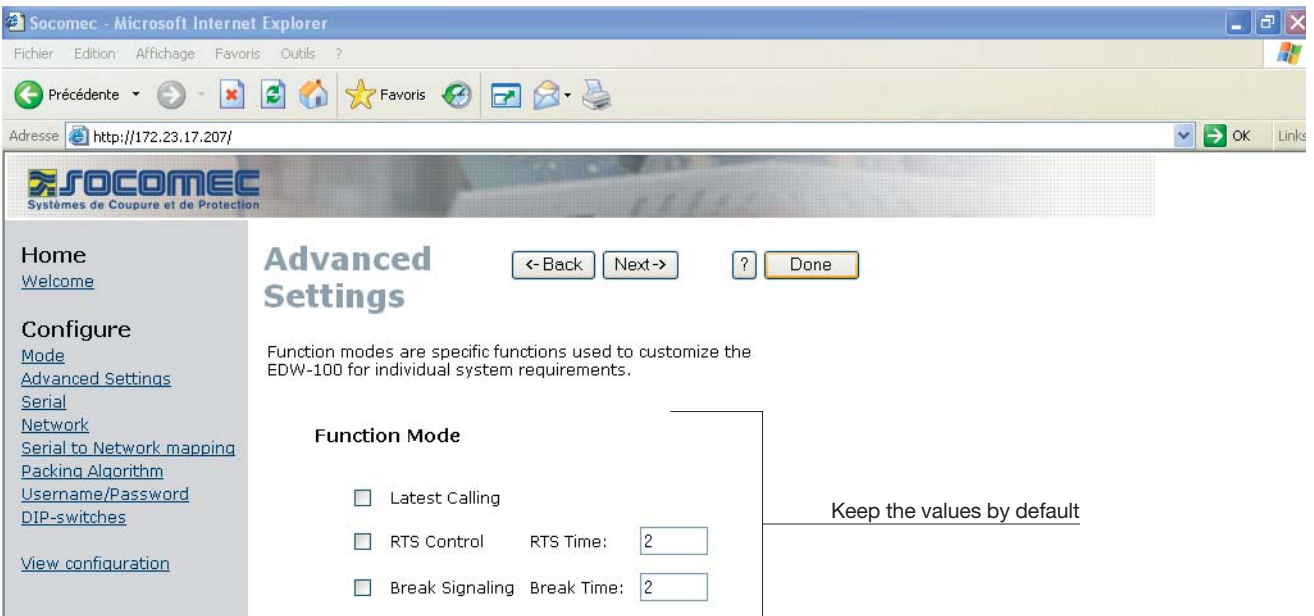
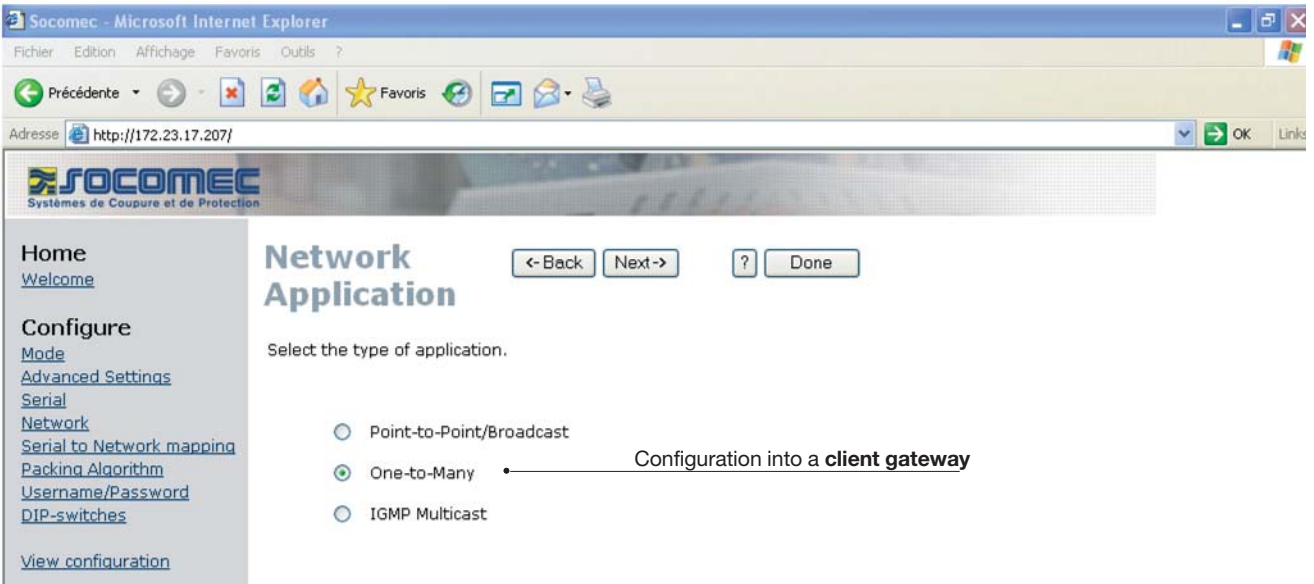

Configuration by Web tool

CLIENT GATEWAY CONFIGURATION

> Client Gateway

INTER_079_A

Serial

The serial interface can be configured with the parameters below.

Serial Information

Interface: — Defined in RS232 for **client gateway**

Data Rate:

Data Bits:

Parity: — Defined in accordance with the products configurations (Diris, Countis)

Stop Bits:

Flow Control:

Home
[Welcome](#)

Configure
[Mode](#)
[Advanced Settings](#)
[Serial](#)
[Network](#)
[Serial to Network mapping](#)
[Packing Algorithm](#)
[Username/Password](#)
[DIP-switches](#)
[View configuration](#)

Type
ETHERNET / RS232-RS485

INTER_080_A

Network Address

This page defines the address on the network interface.

Local IP Address, Subnet Mask and Default Gateway are critical for communicating with the unit, so be sure the addresses are correct before saving them.

Address Information

Local IP Address: — **Client gateway address**
See with your IT department, 172.23.17.207 (for the example)

Subnet Mask: — To defined in function of the others gateways addresses
See with your IT department.

Default Gateway: — Gateway address if the network IP changed

Home
[Welcome](#)

Configure
[Mode](#)
[Advanced Settings](#)
[Serial](#)
[Network](#)
[Serial to Network mapping](#)
[Packing Algorithm](#)
[Username/Password](#)
[DIP-switches](#)
[View configuration](#)

Type
ETHERNET / RS232-RS485

PROGRAMMATION ETHERNET

Configuration by Web tool

CLIENT GATEWAY CONFIGURATION

> Client Gateway

Serial to network mapping

This page defines the connection between the network interface and the serial channel.

Mapping to serial channel Gateway port (client or server). Always 502 for a Modbus protocol.

Local Port 1:

Remote IP List:

Enter the **server gateways** addresses. See with your IT department, 172.23.17.208 & 172.23.17.209

INTER_081_A

Packing Algorithm

The packing algorithm can be configured to transmit serial received data immediately to network interface or to buffer data until a transmit requirement is fulfilled.

Packing Algorithm Information

End of Frame Char:

Transmit End of Frame Char:

End of Frame Delay(ms):

Max n.o Chars in Frame:

Keep the values by default

INTER_082_A

Configuration by Web tool

CLIENT GATEWAY CONFIGURATION

> Client Gateway

INTER_083_A

Socomec - Microsoft Internet Explorer

Fichier Edition Affichage Favoris Outils ?

Précédente - Favoris

Adresse http://172.23.17.207/ OK Links

SOCOME C
Systèmes de Coupure et de Protection

Home
[Welcome](#)

Configure
[Mode](#)
[Advanced Settings](#)
[Serial](#)
[Network](#)
[Serial to Network mapping](#)
[Packing Algorithm](#)
[Username/Password](#)
[DIP-switches](#)
[View configuration](#)

Password <- Back Next -> ? Done

The Username and Password settings are used for Web tool and Telnet login.

Access Information

Username: Password: Enter the username and the password wanted

INTER_084_A

Socomec - Microsoft Internet Explorer

Fichier Edition Affichage Favoris Outils ?

Précédente - Favoris

Adresse http://172.23.17.207/ OK Links

SOCOME C
Systèmes de Coupure et de Protection

Home
[Welcome](#)

Configure
[Mode](#)
[Advanced Settings](#)
[Serial](#)
[Network](#)
[Serial to Network mapping](#)
[Packing Algorithm](#)
[Username/Password](#)
[DIP-switches](#)
[View configuration](#)

DIP-switches <- Back Next -> ? Done

The picture of the DIP-switches shows the actual position of the hardware DIP-switches inside the interface ETHERNET RS232-RS485. The hardware DIP-switch values can be remotely overridden using this Web tool. When the Web tool has been used to override the hardware DIP-switches the RC LED on the interface will be illuminated.

To override the hardware DIP-switches press "Override DIP-switches" and set the overriding values.

To disable the software overrides and use the hardware DIP-switches values press "DO NOT Override DIP-switches".

Important! When remotely overriding the hardware DIP-switch settings, ensure that the converter can establish an Ethernet link after reboot. Otherwise the unit will not be remotely configurable and a Factory Reset must be made.

Hardware DIP-switches

ON OFF

1 2 3 4 5 6 7 8

Keep the values by default

Override DIP-switches

Type
ETHERNET / RS232-RS485

Art. no.
4899 0300

Firmware
4100-9003

WebTool Version
1.02

PROGRAMMATION

ETHERNET

Configuration by Web tool

CLIENT GATEWAY CONFIGURATION

> Client Gateway

Socomec - Microsoft Internet Explorer
Fichier Edition Affichage Favoris Outils ?

Adresse <http://172.23.17.207/>

SOCOMEC
Systèmes de Coupure et de Protection

Configure Unit <- Back

Program Unit • Allowed the parameters validation

Save File • Allowed to save the parameters configuration on a file

Load File • Allowed to restore the parameters configuration from a file

These settings are not applied in the unit until the Program Unit button is pressed.

Mode	
Application Mode:	UDP
Advanced Settings	
Function Mode:	None
Network	
Local IP address:	172.23.17.207:502
Subnet Mask:	255.255.0.0
Default Gateway:	0.0.0.0
Remote IP address:	0.0.0.0:9000
Second Remote IP:	0.0.0.0:9000
Remote IP List:	172.23.17.208:502 172.23.17.209:502
Multicast address:	0.0.0.0
Serial	
Interface:	RS-232
Data rate:	9600 bits/s
Data bits:	8 bits
Parity:	None
Stop bits:	1 bit
Flow control:	None
Packing Algorithm	
End of Frame Char:	256

Home
[Welcome](#)

Configure
[Mode](#)
[Advanced Settings](#)
[Serial](#)
[Network](#)
[Serial to Network mapping](#)
[Packing Algorithm](#)
[Username/Password](#)
[DIP-switches](#)

[View configuration](#)

Type
ETHERNET / RS232-RS485

Art. no.
4899 0300

Firmware
4100-9003

WebTool Version
1.02

Local intranet

INTER_065_A

Configuration by Web tool

SERVER GATEWAY CONFIGURATION

> Server Gateway n° 1

Socomec - Microsoft Internet Explorer
Fichier Edition Affichage Favoris Outils ?

Adresse <http://172.23.17.208>

SOCOME C
Systèmes de Coupure et de Protection

Welcome

This Web tool is used for a quick and easy setup of the interface ETHERNET / RS232-RS485. Each configuration topic can be setup section by section or a Configuration Wizard will guide you through the configuration.

An detailed description of all parameters can be seen using the HELP button on each page.

To refresh the parameters displayed on each page press the "Read Configuration" button or press the F5 key.

Please note while using the Web tool the throughput of data may decrease.

A description for each item in the menu beside are in the list below.

Configure

Mode	- Set the unit in UDP, TCP server or TCP client mode
Advanced Settings	- Set the unit in a specific function mode
Serial	- Serial interface settings
Network Address	- Address settings of the network interface
Serial to network mapping	- Mapping serial to network settings
Packing Algorithm	- Packing Algorithm settings
Username/Password	- Username and Password for the units login
Dip Switches	- Dip Switch settings
View Configuration	- Load/Save or Write configuration

Begin the configuration here

Terminé Local intranet

Socomec - Microsoft Internet Explorer
Fichier Edition Affichage Favoris Outils ?

Adresse <http://172.23.17.208>

SOCOME C
Systèmes de Coupure et de Protection

Mode

<- Back Next-> ? Done

Application mode sets the IP protocol to be used by the unit. The options are for UDP or to act as a TCP server or TCP client.

Application Mode

Mode:

Protocol choice.
Keep UDP

PROGRAMMATION **ETHERNET**

Configuration by Web tool

SERVER GATEWAY CONFIGURATION

> Server Gateway n° 1

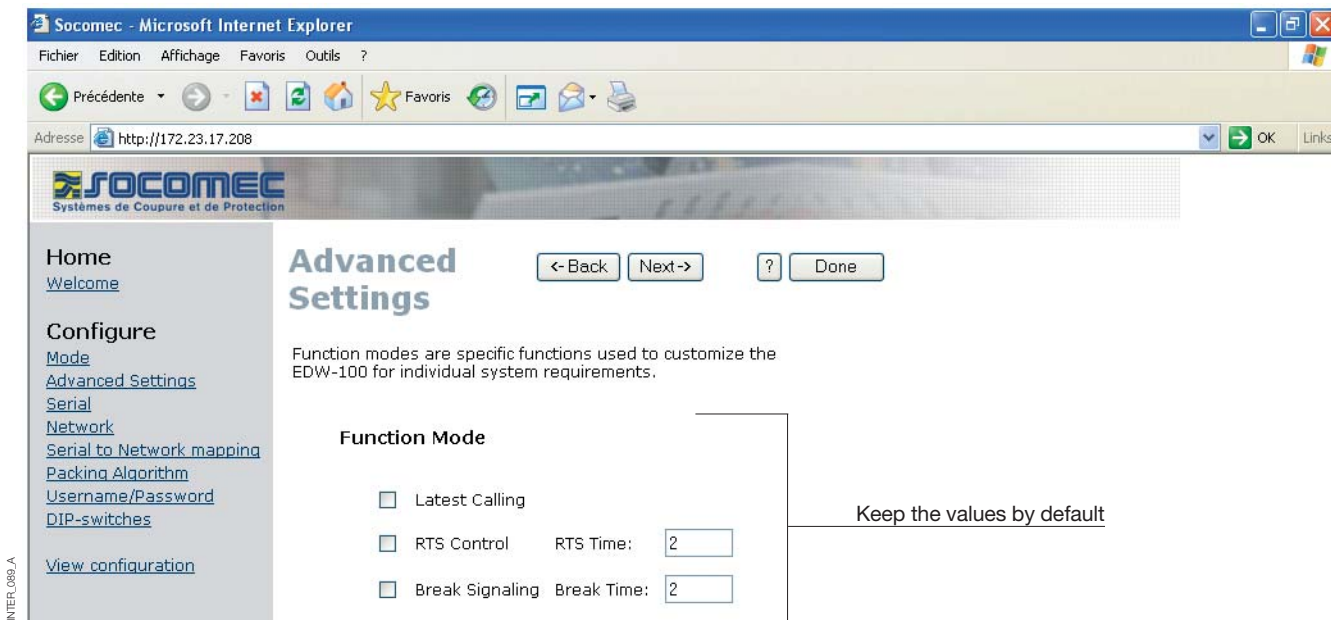
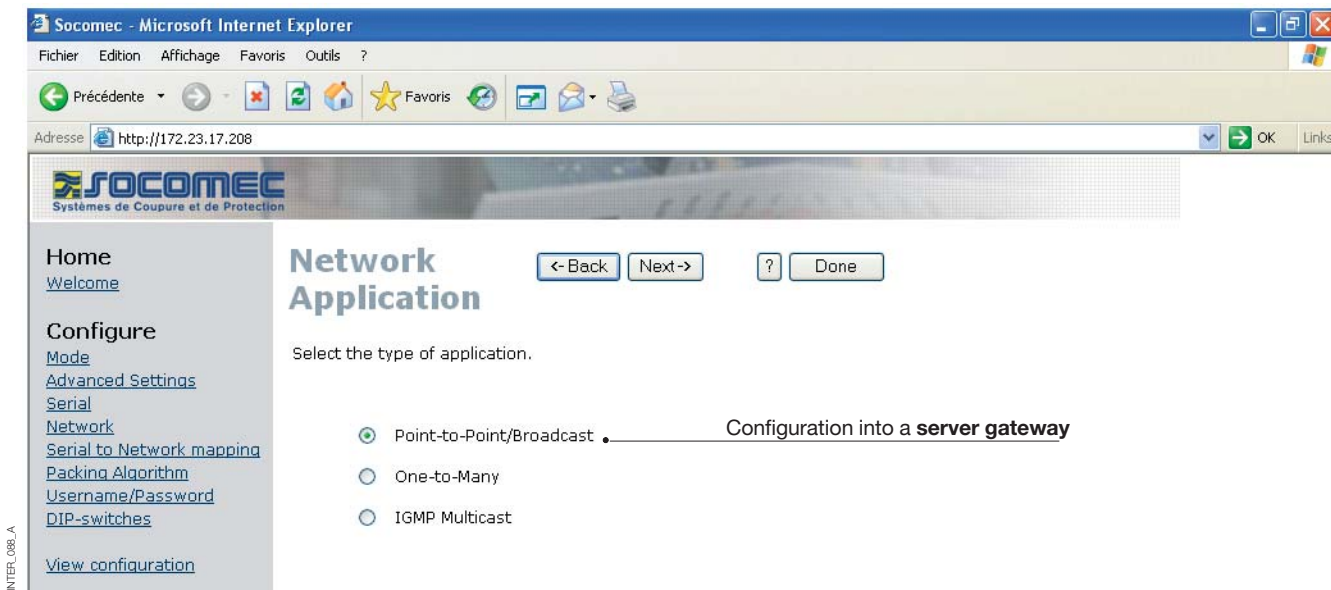

INTER_088_A

INTER_089_A

Configuration by Web tool

SERVER GATEWAY CONFIGURATION

> Server Gateway n° 1

Serial

The serial interface can be configured with the parameters below.

Serial Information

Interface: — Defined in RS485 for client gateway

Data Rate:

Data Bits:

Parity:

Stop Bits:

Flow Control:

— Defined in accordance with the products configurations (Diris, Countis)

Network Address

This page defines the address on the network interface.

Local IP Address, Subnet Mask and Default Gateway are critical for communicating with the unit, so be sure the addresses are correct before saving them.

Address Information

Local IP Address: — **Server gateway address**
See with your IT department, 172.23.17.208 (for the example)

Subnet Mask: — To defined in function of the others gateways addresses
See with your IT department.

Default Gateway: — Gateway address if the network IP changed

PROGRAMMATION ETHERNET

Configuration by Web tool

SERVER GATEWAY CONFIGURATION

> Server Gateway n° 1

INTER_092_A

The screenshot shows the 'Serial to network mapping' configuration page in a Microsoft Internet Explorer browser window. The browser address bar shows 'http://172.23.17.208'. The page title is 'Serial to network mapping' and it includes navigation buttons for '<- Back', 'Next ->', '?', and 'Done'. The main content area contains the following text: 'This page defines the connection between the network interface and the serial channel.' Below this is a diagram titled 'Mapping to serial channel' showing a vertical line representing a serial channel. To the right of the diagram, it says 'Gateway port (client or server). Always 502 for a Modbus protocol.' Below the diagram are three input fields: 'Local Port 1:' with the value '502', 'Remote IP Address 1:' with the value '172.23.17.207', and 'Remote Port 1:' with the value '502'. To the right of these fields, there is a note: 'Enter the **client gateway** address. See with your IT department, 172.23.17.207'. On the left side of the page, there is a sidebar with a 'Configure' menu containing links for 'Mode', 'Advanced Settings', 'Serial', 'Network', 'Serial to Network mapping', 'Packing Algorithm', 'Username/Password', and 'DIP-switches'. At the bottom of the sidebar, it says 'Type ETHERNET / RS232-RS485'.

INTER_093_A

The screenshot shows the 'Packing Algorithm' configuration page in a Microsoft Internet Explorer browser window. The browser address bar shows 'http://172.23.17.208'. The page title is 'Packing Algorithm' and it includes navigation buttons for '<- Back', 'Next ->', '?', and 'Done'. The main content area contains the following text: 'The packing algorithm can be configured to transmit serial received data immediately to network interface or to buffer data until a transmit requirement is fulfilled.' Below this is a section titled 'Packing Algorithm Information' with four input fields: 'End of Frame Char:' with the value '256', 'Transmit End of Frame Char:' with a dropdown menu set to 'Yes', 'End of Frame Delay(ms):' with the value '20', and 'Max n.o Chars in Frame:' with the value '1000'. To the right of these fields, there is a note: 'Keep the values by default'. On the left side of the page, there is a sidebar with a 'Configure' menu containing links for 'Mode', 'Advanced Settings', 'Serial', 'Network', 'Serial to Network mapping', 'Packing Algorithm', 'Username/Password', and 'DIP-switches'. At the bottom of the sidebar, it says 'Type'.

Configuration by Web tool

SERVER GATEWAY CONFIGURATION

> Server Gateway n° 1

INTER_094_A

Socomec - Microsoft Internet Explorer

Fichier Edition Affichage Favoris Outils ?

Adresse http://172.23.17.208

SOCOME
Systèmes de Coupure et de Protection

Home
Welcome

Configure
Mode
Advanced Settings
Serial
Network
Serial to Network mapping
Packing Algorithm
Username/Password
DIP-switches
View configuration

Password <- Back Next -> ? Done

The Username and Password settings are used for Web tool and Telnet login.

Access Information

Username: SOCOME Enter the username and the password wanted

Password: SOCOME

INTER_095_A

Socomec - Microsoft Internet Explorer

Fichier Edition Affichage Favoris Outils ?

Adresse http://172.23.17.208

SOCOME
Systèmes de Coupure et de Protection

Home
Welcome

Configure
Mode
Advanced Settings
Serial
Network
Serial to Network mapping
Packing Algorithm
Username/Password
DIP-switches
View configuration

DIP-switches <- Back Next -> ? Done

The picture of the DIP-switches shows the actual position of the hardware DIP-switches inside the interface ETHERNET / RS232-RS485. The hardware DIP-switch values can be remotely overridden using this Web tool. When the Web tool has been used to override the hardware DIP-switches the RC LED on the converter will be illuminated.

To override the hardware DIP-switches press "Override DIP-switches" and set the overriding values.

To disable the software overrides and use the hardware DIP-switches values press "DO NOT Override DIP-switches".

Important! When remotely overriding the hardware DIP-switch settings, ensure that the interface can establish an Ethernet link after reboot. Otherwise the unit will not be remotely configurable and a Factory Reset must be made.

Hardware DIP-switches

Keep the values by default

Override DIP-switches

Type
ETHERNET / RS232-RS485

Art. no.
4899 0300

Firmware
4100-9003

WebTool Version
1.02

PROGRAMMATION

ETHERNET

Configuration by Web tool

SERVER GATEWAY CONFIGURATION

> Server Gateway n° 1

Home
Welcome

Configure
Mode
Advanced Settings
Serial
Network
Serial to Network mapping
Packing Algorithm
Username/Password
DIP-switches
View configuration

Type
ETHERNET / RS232-RS485
Art. no.
4899 0300
Firmware
4100-9003
WebTool Version
1.02

Configure Unit <- Back

These settings are not applied in the unit until the Program Unit button is pressed.

Mode
Application Mode: UDP

Advanced Settings
Function Mode: None

Network
Local IP address: 172.23.17.208:502
Subnet Mask: 255.255.0.0
Default Gateway: 0.0.0.0
Remote IP address: 172.23.17.207:502
Second Remote IP: 0.0.0.0:9000
Remote IP List: 172.23.17.208:502
172.23.17.209:502
Multicast address: 0.0.0.0

Serial
Interface: RS-422/485 2-wire
Data rate: 9600 bits/s
Data bits: 8 bits
Parity: None
Stop bits: 1 bit
Flow control: None

Packing Algorithm
End of Frame Char: 256

Program Unit
Save File
Load File

Allowed the parameters validation
Allowed to save the parameters configuration on a file
Allowed to restore the parameters configuration from a file

Local intranet

INTERLOG_A

Configuration by Web tool

SERVER GATEWAY CONFIGURATION

> Server Gateway n° 2

Socomec - Microsoft Internet Explorer
Fichier Edition Affichage Favoris Outils ?

Adresse <http://172.23.17.209>

SOCOMECC
Systèmes de Coupure et de Protection

Welcome

This Web tool is used for a quick and easy setup of the interface ETHERNET / RS232-RS485. Each configuration topic can be setup section by section or a Configuration Wizard will guide you through the configuration.

An detailed description of all parameters can be seen using the HELP button on each page.

To refresh the parameters displayed on each page press the "Read Configuration" button or press the F5 key.

Please note while using the Web tool the throughput of data may decrease.

A description for each item in the menu beside are in the list below.

Configure	
Mode	- Set the unit in UDP, TCP server or TCP client mode
Advanced Settings	- Set the unit in a specific function mode
Serial	- Serial interface settings
Network Address	- Address settings of the network interface
Serial to network mapping	- Mapping serial to network settings
Packing Algorithm	- Packing Algorithm settings
Username/Password	- Username and Password for the units login
Dip Switches	- Dip Switch settings
View Configuration	- Load/Save or Write configuration

Home
[Welcome](#)

Configure
[Mode](#)
[Advanced Settings](#)
[Serial](#)
[Network](#)
[Serial to Network mapping](#)
[Packing Algorithm](#)
[Username/Password](#)
[DIP-switches](#)
[View configuration](#)

Type
ETHERNET / RS232-RS485
Art. no.
4899 0300
Firmware
4100-9003
WebTool Version
1.02

Configuration Wizard **Read Configuration**

Begin the configuration here

Terminé Local intranet

Socomec - Microsoft Internet Explorer
Fichier Edition Affichage Favoris Outils ?

Adresse <http://172.23.17.209>

SOCOMECC
Systèmes de Coupure et de Protection

Mode

<- Back Next-> ? Done

Application mode sets the IP protocol to be used by the unit. The options are for UDP or to act as a TCP server or TCP client.

Application Mode

Mode:

Protocole choice.
Keep UDP

Home
[Welcome](#)

Configure
[Mode](#)
[Advanced Settings](#)
[Serial](#)
[Network](#)
[Serial to Network mapping](#)
[Packing Algorithm](#)
[Username/Password](#)
[DIP-switches](#)
[View configuration](#)

PROGRAMMATION **ETHERNET**

Configuration by Web tool

SERVER GATEWAY CONFIGURATION

> Server Gateway n° 2

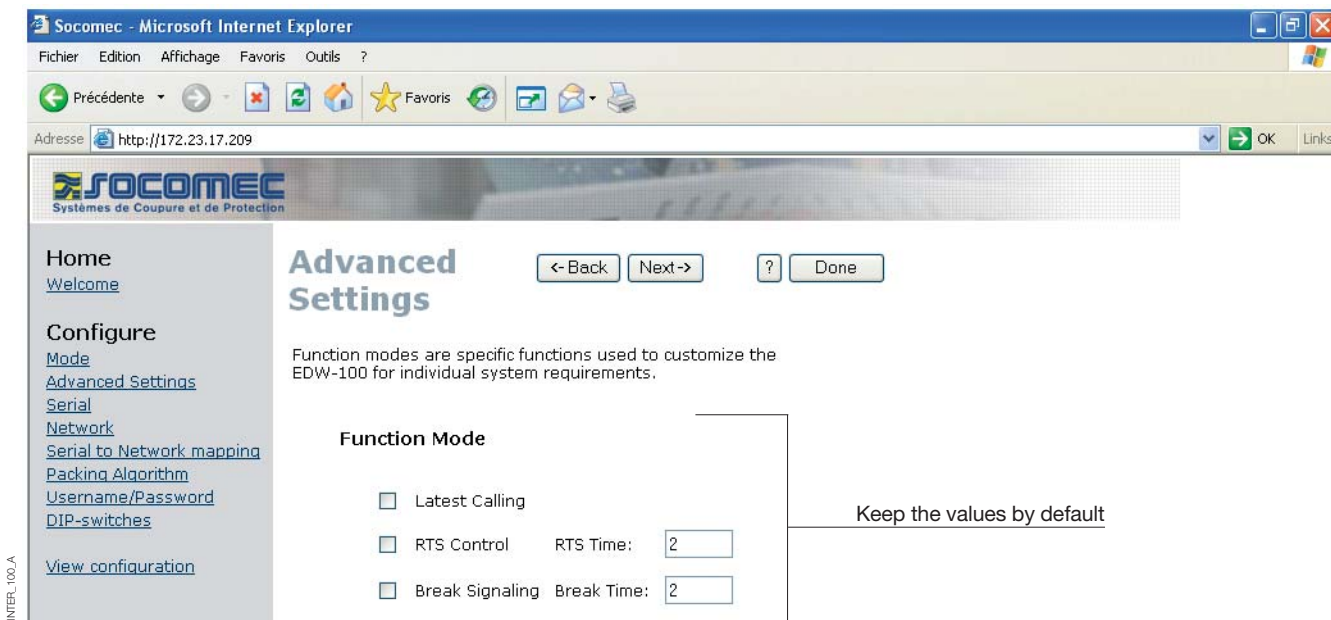
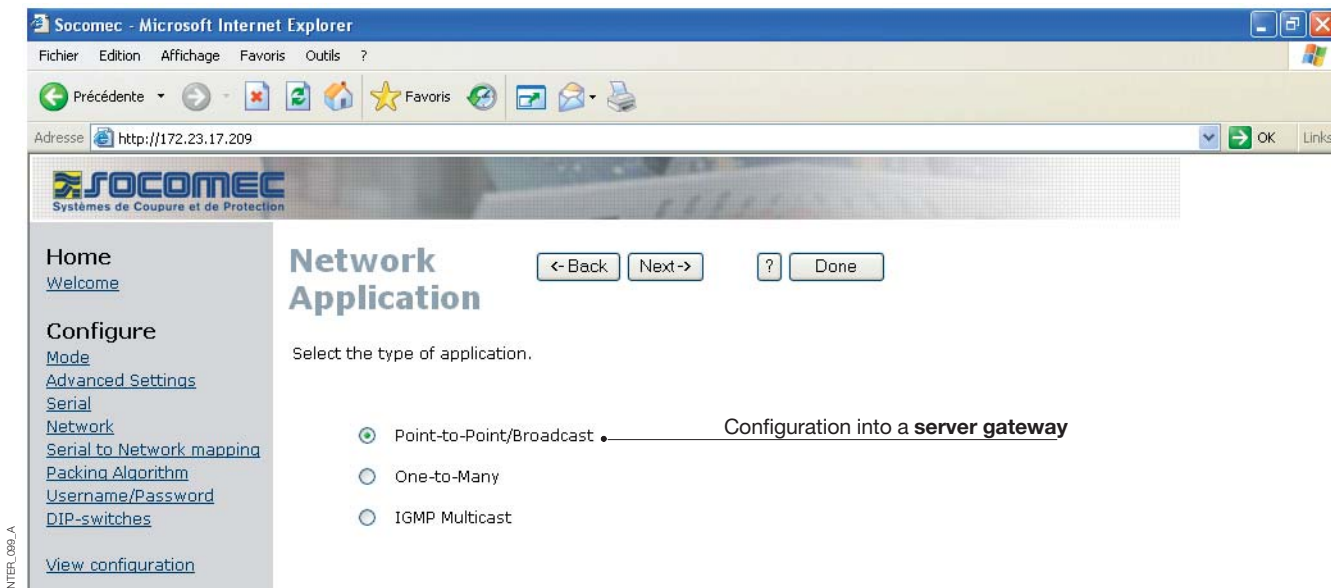

INTER_086_A

INTER_100_A

Configuration by Web tool

SERVER GATEWAY CONFIGURATION

> Server Gateway n° 2

INTER_100_A

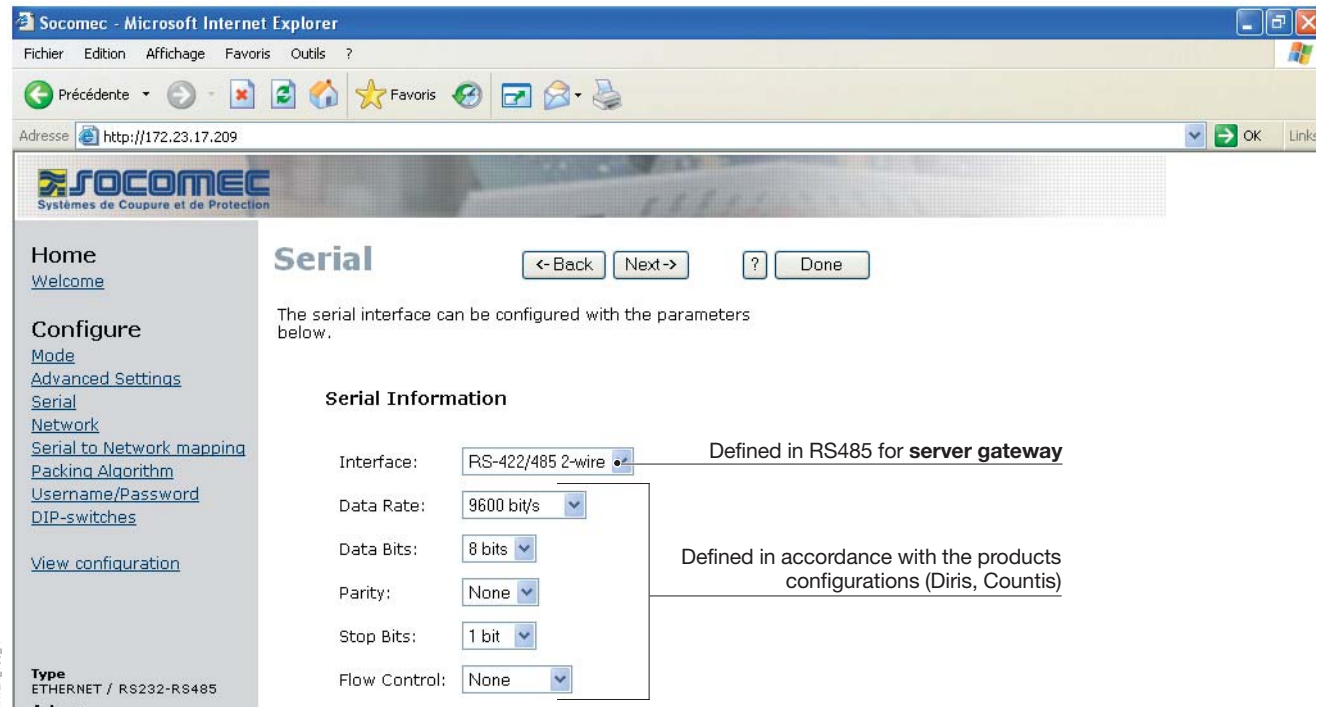

Serial

The serial interface can be configured with the parameters below.

Serial Information

Interface: RS-422/485 2-wire Defined in RS485 for **server gateway**

Data Rate: 9600 bit/s

Data Bits: 8 bits Defined in accordance with the products configurations (Diris, Countis)

Parity: None

Stop Bits: 1 bit

Flow Control: None

Type
ETHERNET / RS232-RS485

INTER_102_A

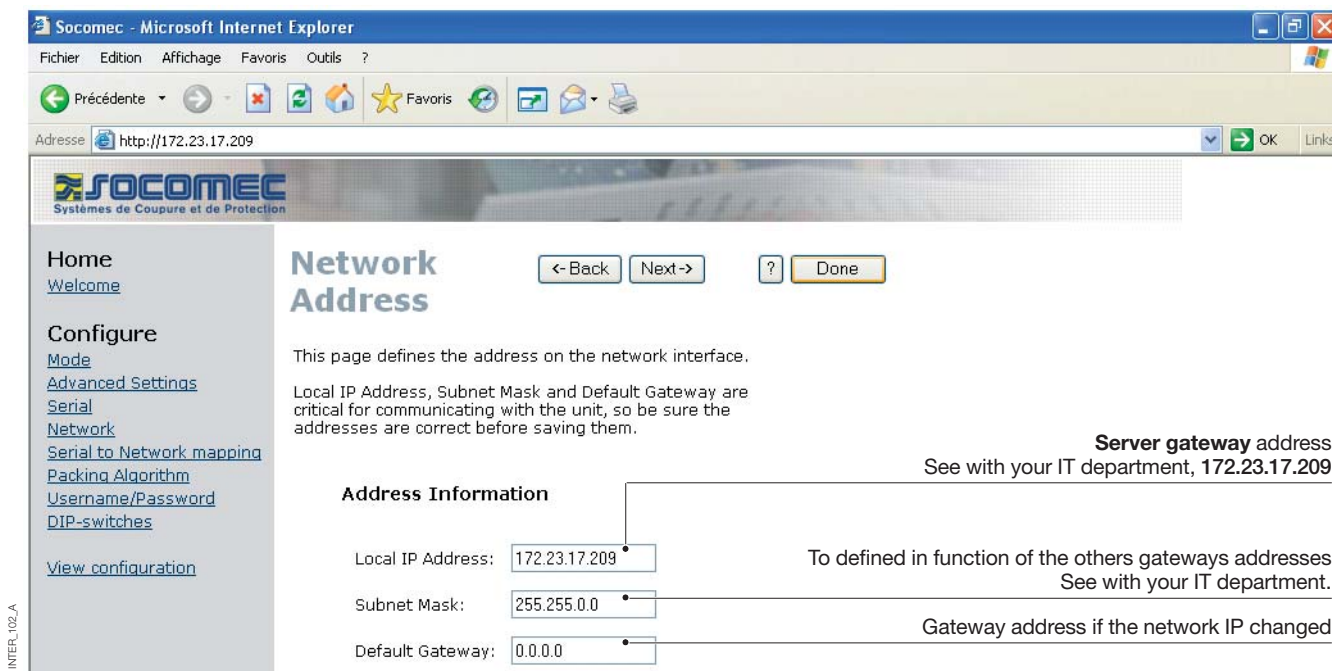

Network Address

This page defines the address on the network interface.

Local IP Address, Subnet Mask and Default Gateway are critical for communicating with the unit, so be sure the addresses are correct before saving them.

Address Information

Local IP Address: 172.23.17.209 To defined in function of the others gateways addresses
See with your IT department.

Subnet Mask: 255.255.0.0

Default Gateway: 0.0.0.0 Gateway address if the network IP changed

Server gateway address
See with your IT department, 172.23.17.209

PROGRAMMATION ETHERNET

Configuration by Web tool

SERVER GATEWAY CONFIGURATION

> Server Gateway n° 2

Serial to network mapping

This page defines the connection between the network interface and the serial channel.

Mapping to serial channel Gateway port (client or server). Always 502 for a Modbus protocol.

Local Port 1:

Remote IP Address 1:

Remote Port 1:

Enter the **client gateway** address. See with your IT department, 172.23.17.207

Home
Welcome

Configure
Mode
Advanced Settings
Serial
Network
Serial to Network mapping
Packing Algorithm
Username/Password
DIP-switches
View configuration

Type
ETHERNET / RS232-RS485

INTER_103_A

Packing Algorithm

The packing algorithm can be configured to transmit serial received data immediately to network interface or to buffer data until a transmit requirement is fulfilled.

Packing Algorithm Information

End of Frame Char:

Transmit End of Frame Char:

End of Frame Delay(ms):

Max n.o Chars in Frame:

Keep the values by default

Home
Welcome

Configure
Mode
Advanced Settings
Serial
Network
Serial to Network mapping
Packing Algorithm
Username/Password
DIP-switches
View configuration

Type
ETHERNET / RS232-RS485

INTER_104_A

Configuration by Web tool

SERVER GATEWAY CONFIGURATION

> Server Gateway n° 2

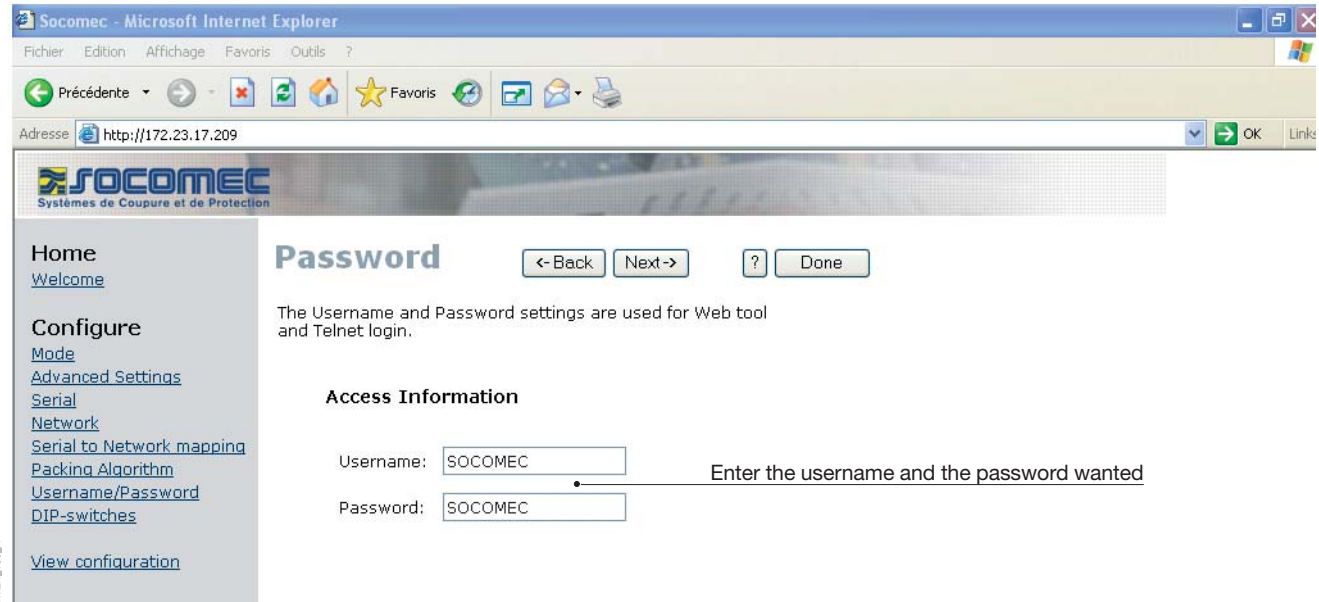

INTER_105_A



INTER_105_A

PROGRAMMATION

ETHERNET

Configuration by Web tool

SERVER GATEWAY CONFIGURATION

> Server Gateway n° 2

The screenshot shows a Microsoft Internet Explorer browser window displaying the Socomec web interface. The address bar shows <http://172.23.17.209>. The page title is "Socomec - Microsoft Internet Explorer". The main content area is titled "Configure Unit" and includes a navigation menu on the left and a central configuration table. The configuration table lists various parameters under different sections: Mode, Advanced Settings, Network, and Serial. The "Program Unit" button is highlighted with a callout box stating "Allowed the parameters validation". The "Save File" button is highlighted with a callout box stating "Allowed to save the parameters configuration on a file". The "Load File" button is highlighted with a callout box stating "Allowed to restore the parameters configuration from a file".

Configure Unit Allowed the parameters validation

Allowed to save the parameters configuration on a file

Allowed to restore the parameters configuration from a file

These settings are not applied in the unit until the Program Unit button is pressed.

Mode	
Application Mode:	UDP
Advanced Settings	
Function Mode:	None
Network	
Local IP address:	172.23.17.209:502
Subnet Mask:	255.255.0.0
Default Gateway:	0.0.0.0
Remote IP address:	172.23.17.207:502
Second Remote IP:	0.0.0.0:9000
Remote IP List:	172.23.17.208:502 172.23.17.209:502
Multicast address:	0.0.0.0
Serial	
Interface:	RS-422/485 2-wire
Data rate:	9600 bits/s
Data bits:	8 bits
Parity:	None
Stop bits:	1 bit
Flow control:	None
Packing Algorithm	
End of Frame Char:	256

Home
[Welcome](#)

Configure
[Mode](#)
[Advanced Settings](#)
[Serial](#)
[Network](#)
[Serial to Network mapping](#)
[Packing Algorithm](#)
[Username/Password](#)
[DIP-switches](#)

[View configuration](#)

Type
ETHERNET / RS232-RS485
Art. no.
4899 0300
Firmware
4100-9003
WebTool Version
1.02

Terminé Local intranet

INTER-107.A

APPLICATION EXAMPLES

ETHERNET

RS485 termination

TERMINATION RECOMMENDATIONS

The RS485 line must be terminated regardless of the cable length. The termination is ideally placed at the extreme ends of the cable see examples above. The description of the RS485 pin outs will vary between manufactures. For some brands the T+ corresponds to

A T- to B, R+ to A' and R- to B', but other brands might use some other naming convention. If a unit does not work it can help to swap A and B. If difficulty is being experience contact Socomec for further guidance.

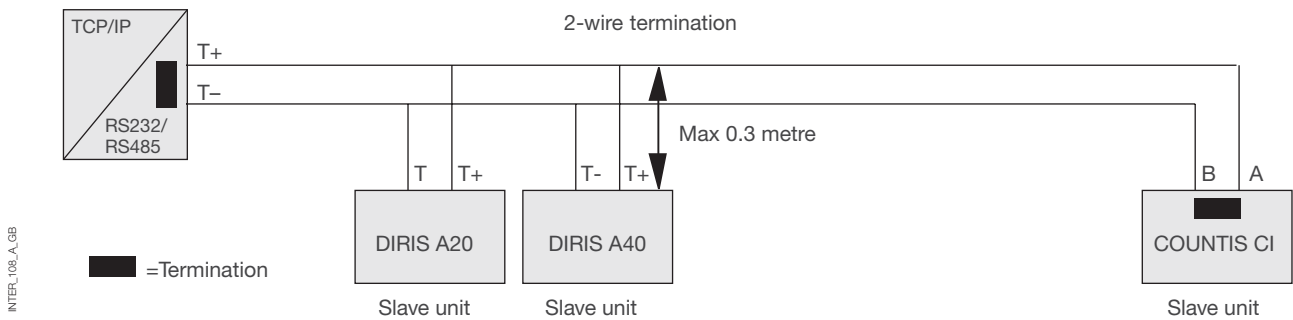

One to many using UDP using broadcast or multicast

DESCRIPTION

The one to many function can be used in place of a traditional RS485 multidrop application. Data entering one of the interface will be broadcast or Multicast to any

other device in the broadcast or multicast group. A typical application would be a SCADA host computer communicating to a number of PLC's.

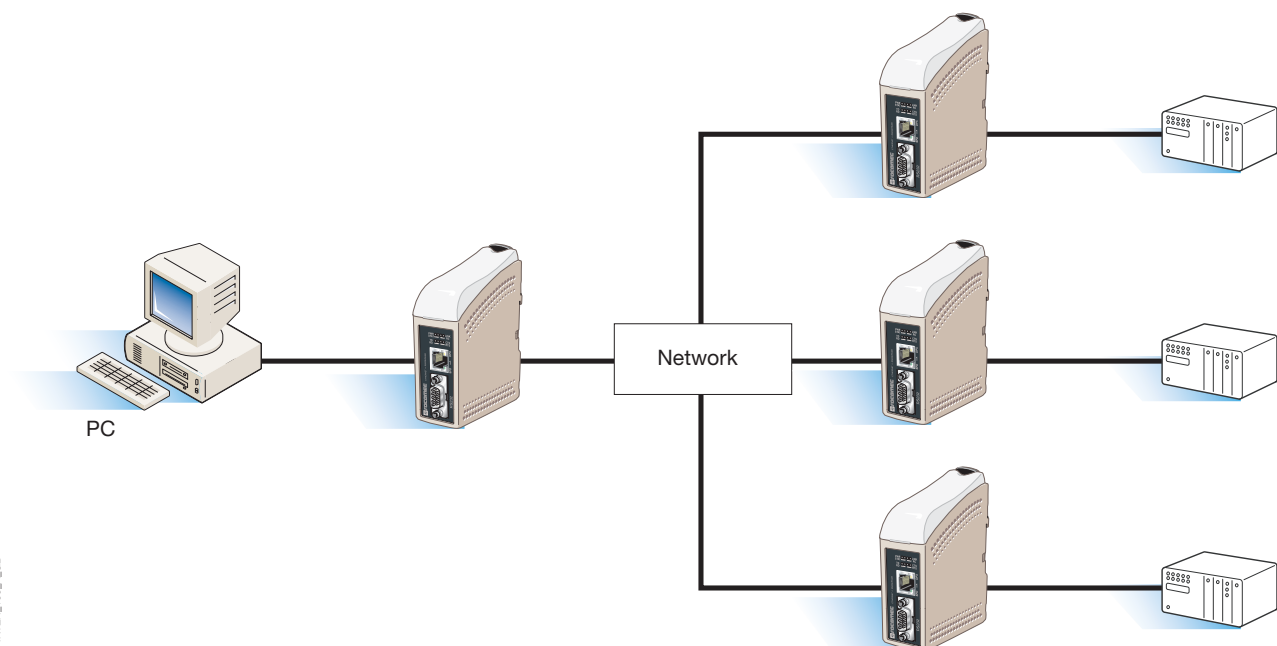

APPLICATION EXAMPLES

ETHERNET

Point to point using TCP connection, server and client

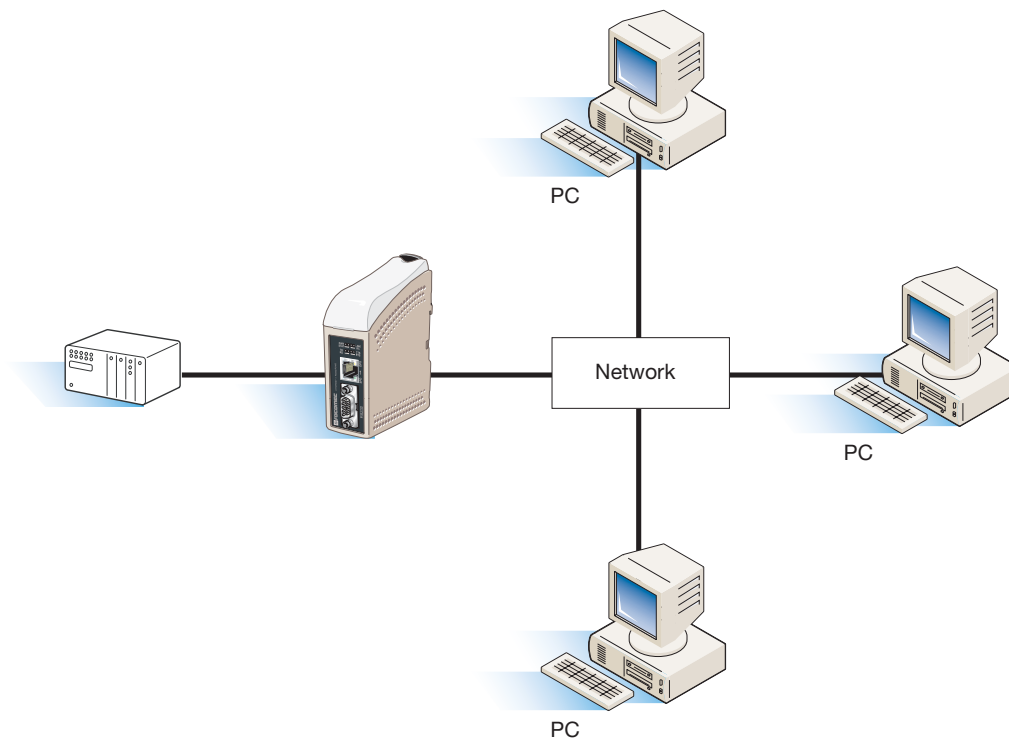

INTER_110_A_GB

Point to point using UDP connection

DESCRIPTION

In a point to point application the interface can be to replace or extend a cable link. The distance between the converter units is only limited by the size of the LAN.

Data can be sent across the network using ether UDP or TCP. A typical application would be a SCADA or Data logging application interrogating a sensor or PLC.

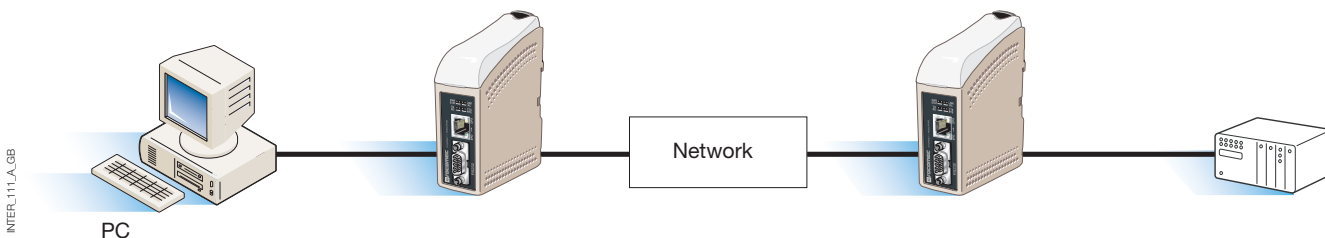

INTER_111_A_GB

Communication one to many using TCP

DESCRIPTION

Many legacy software applications do not have any facilities to directly use Ethernet but there is a requirement to use a newly installed or existing LAN to communication to many serial devices. This problem is solved by installing Comms redirection software on the host PC. The redirection software works by creating virtual comms ports on the computer. The Virtual comms port can be selected and use in the same way as a hardware based port. The Comms redirection software will encapsulate

the serial data in a TCP-IP and send it to the relevant interface device. The interface will then strip off the TCP-IP frame and just forward the serial data to the target device. In the reverse direction the interface will encapsulate the data and the comms redirection software will strip off the TCP-IP frame. The Comms redirection software can create up to 255 serial comms ports on a single computer.

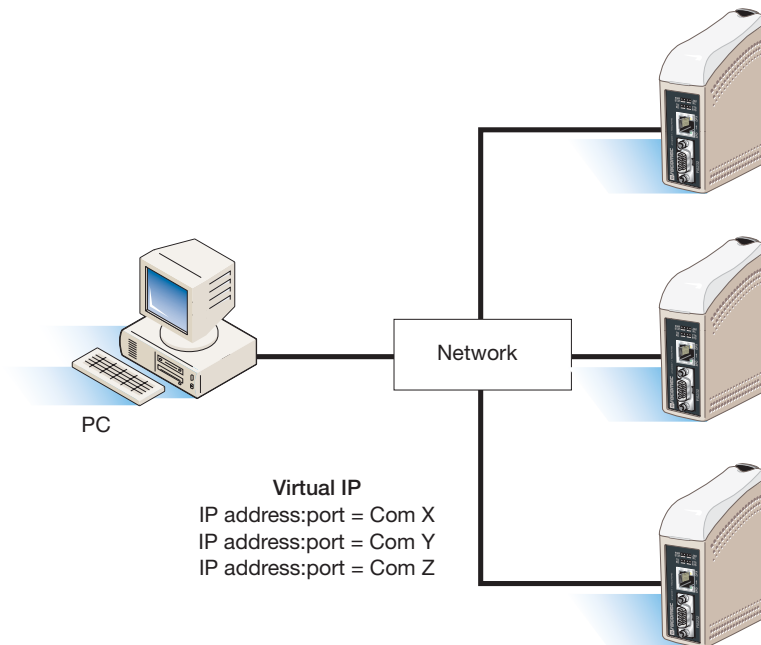

INTER_112_A_GB

HEAD OFFICE

SOCOMEK GROUP SWITCHING PROTECTION & UPS
S.A. capital 11 014 300 €
R.C. Strasbourg 548500 149 B
1, Rue de Westhouse - B.P. 10 - F-67235 Benfeld Cedex - FRANCE

www.socomec.com

INTERNATIONAL SALES DEPARTMENT

SOCOMEK
1, rue de Westhouse - B.P. 10
F - 67235 Benfeld Cedex - FRANCE
Tél. +33 (0)3 88 57 41 41 - Fax +33 (0)3 88 74 08 00
scp.vex@socomec.com

This document is not a contract. SOCOMEK reserves the right to modify features without prior notice in view of continued improvement.