



EN FR
DE ES
IT PT
NL TR
PL ZH



Declaration of conformity
EU-type examination certificate
User Manual:
www.socomec.com/en/diris-a14

www.socomec.com

1 Dual dimensions : in/mm

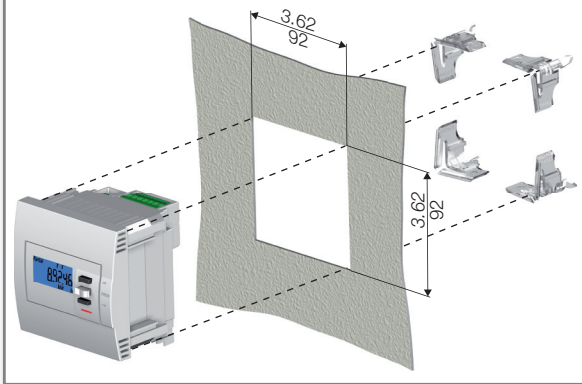
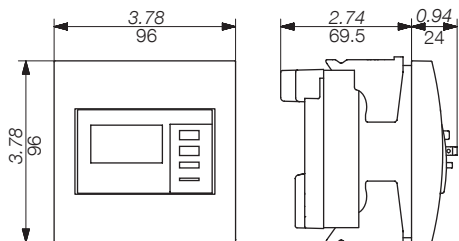

EN Three-phase Digital Energy meters

This equipment must be mounted only by professionals. The manufacturer cannot be held liable for any failure to follow the instructions given in this document and in document 542957 which can be downloaded from the website: www.socomec.com.

- ⚠ Risk of electrocution, burns or explosion**
 - this device must only be installed and maintained by qualified and duly authorised personnel
 - always use a suitable voltage tester to ensure there is no voltage supplied to the device
 - put all mechanisms, door and covers back in place before energising the device
 - always supply the device with the correct rated voltage
- ⚠ Risk of damaging device**

Chek the following :

 - the frequency of the distribution system 50 Hz
 - the maximum voltage at the voltage input terminals is 265 VAC phase / neutral
 - a maximum current of 6 A

FR Compteur d'énergie triphasé

Le montage de ces matériels ne peut être effectué que par des professionnels. Le non respect des indications de la présente notice ainsi que la notice générale 542957 téléchargeable sur le site : www.socomec.com ne saurait engager la responsabilité du constructeur.

- ⚠ Risque d'électrocution, de brûlures ou d'explosion**
 - L'installation et l'entretien de cet appareil ne doivent être effectués que par du personnel qualifié et habilité
 - utilisez toujours un vérificateur d'absence de tension approprié pour confirmer l'absence de tension
 - remplacez tous les dispositifs, les portes et les couvercles avant de mettre cet appareil sous tension
 - utilisez toujours la tension assignée appropriée pour alimenter cet appareil
- ⚠ Risque de détérioration de l'appareil**

Veillez à respecter :

 - la fréquence du réseau 50 Hz
 - une tension maximum aux bornes des entrées tension de 265 VAC phase / neutre
 - un courant maximum de 6 A

DE Wirkenergiezähler für Drei-phasige Netze

Die Montage muss von einem Fachmann vorgenommen werden. Werden die Anweisungen der vorliegenden Anweisung sowie die allgemeine Bedienungsanleitung 542957, die auf der Website: www.socomec.com heruntergeladen werden kann, nicht beachtet, entfällt die Haftung des Herstellers.

- ⚠ Gefahr von Stromschlägen, Verbrennungen oder Explosionen**
 - Dieses Gerät darf nur von einer entsprechend qualifizierten und befugten Personen installiert und gewartet werden.
 - Stellen Sie mit Hilfe eines geeigneten Spannungsanzeigergeräts sicher, dass keine Spannung anliegt.
 - Alle Vorrichtungen, Türen und Deckel vor dem erneuten Einschalten des Gerätes wieder anbringen.
 - Nur die vorgegebene Spannung zur Versorgung des Gerätes verwenden.
- ⚠ Gefahr einer Beschädigung des Gerätes**

Bitte beachten Sie:

 - Die Netzfrequenz 50 Hz
 - Eine maximale Spannung an den Spannungseingangsklemmen von 265 V Phase / Neutral
 - Einen maximalen Strom von 6 A

IT Contatore di energia trifase

Questi prodotti devono essere montati esclusivamente da professionisti: Il mancato rispetto delle indicazioni contenute nel presente manuale o nel file 542957 scaricabile sul sito www.socomec.com, solleva il costruttore da ogni responsabilità.

- ⚠ Rischi di folgorazione, ustioni o esplosione.**
 - L'installazione e la manutenzione ordinaria di questo apparecchio devono essere effettuate esclusivamente da personale qualificato e abilitato.
 - Utilizzare sempre un opportuno dispositivo di rilevamento di tensione per confermare l'assenza di tensione.
 - Rimontare tutti i dispositivi, le portelle e i coperchi prima di mettere l'apparecchio sotto tensione.
 - utilizzare sempre la tensione opportuna per alimentare questo apparecchio.
- ⚠ Rischi di deterioramento dell'apparecchio.**

Attenzione rispettare:

 - La frequenza di rete 50 Hz.
 - Una tensione massima ai morsetti degli ingressi di tensione da 265 VAC fase / neutro.
 - Una corrente massima di 6 A.

ES Contadores de energía trifásicas

El montaje de esto materiales sólo puede ser efectuado por profesionales. Si no se cumplen la indicaciones mencionadas en el presente manual o el manual de uso 542957 descargable en www.socomec.com, se excluye cualquier responsabilidad del fabricante.

- ⚠ Riesgo de electrocución, de quemaduras o de explosión**
 - La instalación y el mantenimiento de este equipo deberán correr a cargo de personal cualificado y homologado
 - utilice siempre un comprobador de ausencia de tensión adecuado para confirmar la ausencia de tensión
 - volver a colocar todos los dispositivos, tapas y puertas antes de poner el aparato en tensión
 - utilice siempre la tensión asignada adecuada para alimentar el aparato
- ⚠ Riesgo de deterioro del aparato**

Si requiere respetar:

 - la frecuencia de la red 50 Hz
 - una tensión máxima en los bornes de las entradas de tensión de 265 VAC fase / neutro
 - la intensidad máxima de 6 A

PT Contador de energia trifásica

A montagem destes materiais só pode ser realizada por profissionais. O não cumprimento das indicações deste manual assim como do manual de instrução geral 542957 disponível no site: www.socomec.com, não poderá imputar a responsabilidade do construtor.

- ⚠ Riscos de electrocussão, de queimaduras ou de explosão**
 - a instalação e a manutenção deste aparelho só devem ser efectuadas por pessoal qualificado e com habilitações para tal
 - utilize sempre um verificador de ausência de tensão apropriado, para confirmar a ausência de tensão
 - colocar no sítio todos os dispositivos, as portas e as tampas antes de restabelecer a tensão no aparelho
 - utilizar sempre a tensão de referência apropriada para alimentar o aparelho
- ⚠ Riscos de deterioração do aparelho**

Respeitar:

 - a frequência da rede 50 Hz
 - uma tensão máxima nos terminais das entradas tensão de 265 VAC fase / neutro
 - uma corrente máxima de 6 A

NL Driefasig energieteller

Het monteren van dit materiaal mag enkel gebeuren door professionellen. Bij het niet respecteren van de aanwijzingen in dit instructie-bericht, alsook de algemene instructies 542957, te downloaden op de website www.socomec.com, vervalt de verantwoordelijkheid van de fabricant.

- ⚠ Risico van elektrocutie, brandwonden of explosie**
 - de installatie en het onderhoud van dit apparaat mogen alleen worden uitgevoerd door gekwalificeerd en bekwaam personeel
 - gebruik altijd een goede spanningstester om te controleren of er geen spanning is
 - alle onderdelen, deuren en deksels terugplaatsen alvorens het toestel onder spanning te zetten
 - gebruik altijd de juiste nominale spanning om dit toestel te voeden
- ⚠ Risico van beschadiging van het toestel**

Gelieve de volgende elementen in acht te nemen:

 - de spanning van de hulpvoeding 50 Hz
 - een maximumspanning op de ingangsaansluitingen, spanning van 265 VAC fase / neutraal
 - een maximale stroom van 6 A

TR Üç fazlı Dijital Enerji analizörleri

Bu ekipmanın montajı sadece yetkin kişiler tarafından yapılmalıdır. Bu ve 542957 numaralı dokümandaki montaj talimatlarına www.socomec.com adresinden ulaşılabilir. Bu talimatlar sırasında ortaya çıkacak anızlarda üretici firma sorumlu tutulamaz.

- ⚠ Elektrik çarpması, yanma veya patlama riski**
 - Bu cihazın kurulumu ve bakımı sadece bu işe yetkin ve yeterli bilgiye sahip kişiler tarafından yapılmalıdır.
 - Cihazın besleme gerilimi olup olmadığının emin olmak için her zaman uygun bir gerilim test cihazı kullanın.
 - Cihaza besleme gerilimi uygulamadan önce tüm parçaları ve kapakları yerine monte edin.
 - Cihazı daima nominal çalışma gerilimi ile besleyin.
- ⚠ Arıza riski**

Kontrol edin:

 - Dağıtım sisteminin frekansı 50 Hz
 - Giriş gerilimi max. 265 VAC faz / nötr
 - Max. akım 6 A

PL Trójfazowy licznik energii czynnej

Niniejsze urządzenie powinno być instalowane wyłącznie przez osoby wykwalifikowane. Producent nie ponosi żadnej odpowiedzialności za jakiegokolwiek uszkodzenia wynikające z nieprzestrzegania instrukcji zawartych w niniejszym dokumencie oraz w dokumencie nr 542957 który można pobrać ze strony internetowej: www.socomec.com

- ⚠ Niebezpieczeństwo porażenia prądem, oparzenia lub wybuchu**
 - urządzenie powinno być instalowane i konserwowane wyłącznie przez osoby wykwalifikowane i uprawnione
 - w celu sprawdzenia, czy do urządzenia jest podłączone napięcie, korzystać zawsze z odpowiedniego próbnika napięcia
 - przed podłączeniem urządzenia do zasilania, zamocować wszystkie mechanizmy, drzwiczki i pokrywy na swoim miejscu
 - zawsze zasilac urządzenie odpowiednim napięciem znamionowym
- ⚠ Niebezpieczeństwo uszkodzenia urządzenia:**

Sprawdź:

 - częstotliwość sieci zasilającej 50 Hz
 - czy maksymalne napięcie na zaciskach wejściowych wynosi 265 VAC faza / neutralny
 - maksymalny prąd 6 A

ZH 三相数字式电表

该装置必须由专业人员进行安装。如不遵守本文档及 542957 号文档中的说明使用所产生的任何后果，制造商不承担责任；542957 号文档可在该网站下载：www.socomec.com。

- ⚠ 有触电致死，燃烧以及爆炸的危险**
 - 该装置必须由具备专业资质的人员进行安装与检修
 - 始终使用合适的电压检测装置来确定无电压
 - 在给该装置通电之前，将所有的机械装置、门、封盖都归位
 - 始终供给装置正确的额定电压
- ⚠ 导致装置损坏的风险**

请检查以下几项：

 - 电网频率 50 Hz
 - 电压输入端的最大电压为 265 V 相/中性
 - 最大电流 6 A

Technical characteristics

COMPLIANCE	European EMC Directive No. 2014/30/UE dated 26/02/2014 LV Directive No. 2014/35/UE dated 26/02/2014 Measuring Instrument Directive MID No. 2014/32/UE dated 26/02/2014 EN50470-1/-3 IEC/EN 61557-12 ⁽¹⁾ , IEC/EN 62053-23
SYSTEM CONNECTION Supply types / number of wires	Single phase 2 wires 230V (1BL) / Two phase 2 wires 400V (2BL) Three phase 4 wires 3x230/400 V (4NBL) and three phase 3 wires 3x230 V / 3x400 V (3NBL) ⁽²⁾
Management	Detection of cabling error
Frequency	50 and 60 Hz (± 1 Hz)
Supply	Autosupplied
CONSUMPTION	
Supply	< 10 VA or 2 W
Current circuit	< 1.0 VA
CURRENT (TRMS)	
Starting current (Ist)	5 mA
Minimum current (Imin)	50 mA
Transition current (Itr)	250 mA
Reference current (Iref)	5 A
Permanent overload (Imax)	6 A
Short-term over-current	120 A for 0.5 s (EN50470-3)
VOLTAGE (TRMS)	
Direct measurement	230VAC Phase/Neutral 400VAC Phase/Phase ± 15%
Permanent overload	230 / 400 VAC + 15%
ENERGY	
Active	Yes
Reactive	Yes
Total and partial metering	Yes (0.01 ... 999999.99 kWh / MWh / kvarh / Mvarh)
Bidirectional metering (Ea+, Ea-, Er+, Er-)	Yes
Resolution	10 Wh, 10 varh
ACCURACY	
Active energy (3NBL) Ea+, Ea-	Class C (EN 50470-3)
Active energy (1NBL) Ea+	Class C (EN 50470-3)
Reactive energy Er+, Er-	Class 2 (IEC 62053-23)
TARIFFS⁽³⁾	
Tariff management	Yes
Number of tariffs managed	4
Tariff exchange input	No
METROLOGICAL LED (Ea+, Ea-)	
Impulse weight	10000 impulses / kWh
Colour	Red
DISPLAY	
Type	7 Digit LCD with blue back-lighting
Refresh time	1 s
Back-lighting illumination time	30 s
COMMUNICATION	
RS485	2 wires + shielding / half duplex
Protocol	MODBUS [®] , RTU mode
Speed	4800 / 9600 / 19200 / 38400 Baud
Galvanic insulation	4 kV 1 min 50Hz
BACKUP	
Energy registers	In non-volatile memory
Clock	On battery
Load curve ⁽³⁾	In non-volatile memory
ENVIRONMENTAL CONDITIONS	
Mechanical environment	M1
Electromagnetic environment	E2
Operating temperature	- 10 °C ... + 55 °C
Storage temperature	- 20 °C ... + 70 °C
Humidity	95% RH without condensation
Installation	Indoor, must be installed under an IP51 box
CASE	
Dimensions L x H x D (mm)	96 x 96 x 69,5
Mounting	On door
Connection capacity	See chapter 2
Nominal tightening torque	See chapter 2
Case type / insulation class	Class II (EN 50470-1)
Weight	450 g
REFERENCE	
DIRIS A14 PMD - MID Panel-mount	Ref. 4825 0021

(1) Measurements compliance - (2) In 3NBL network the voltage must be balanced.
(3) Functions available only via communication, the complete list of these functions is given in the downloadable MODBUS communication table.

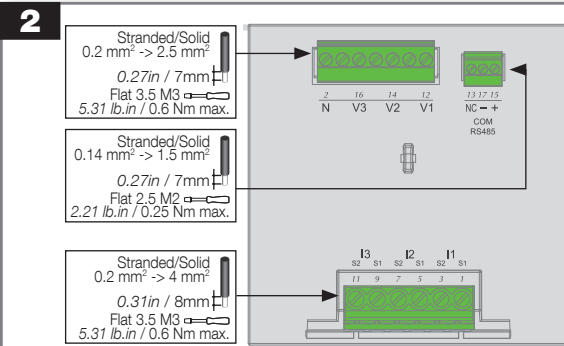

3P+N – 3CT (4NBL)

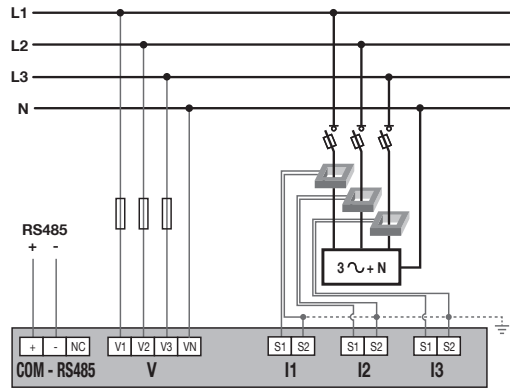

3P – 3CT (3NBL)

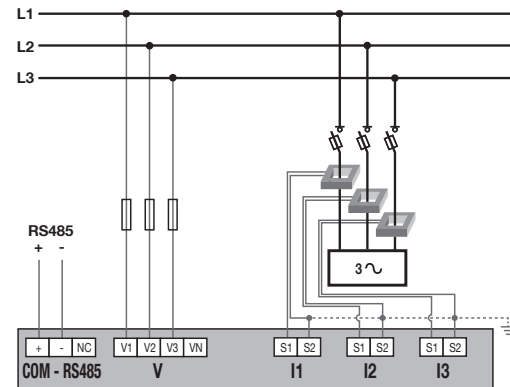

1P+N – 1CT (1BL)

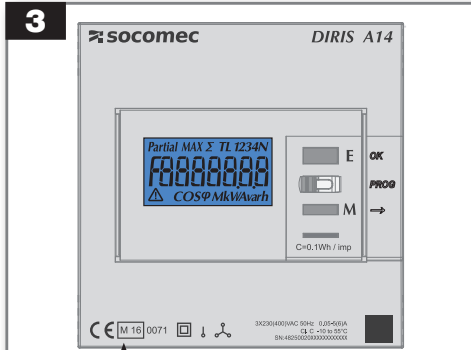
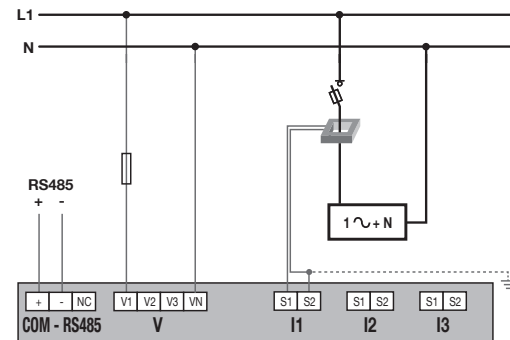

MID
Device code and certification data indications

Sealing kit

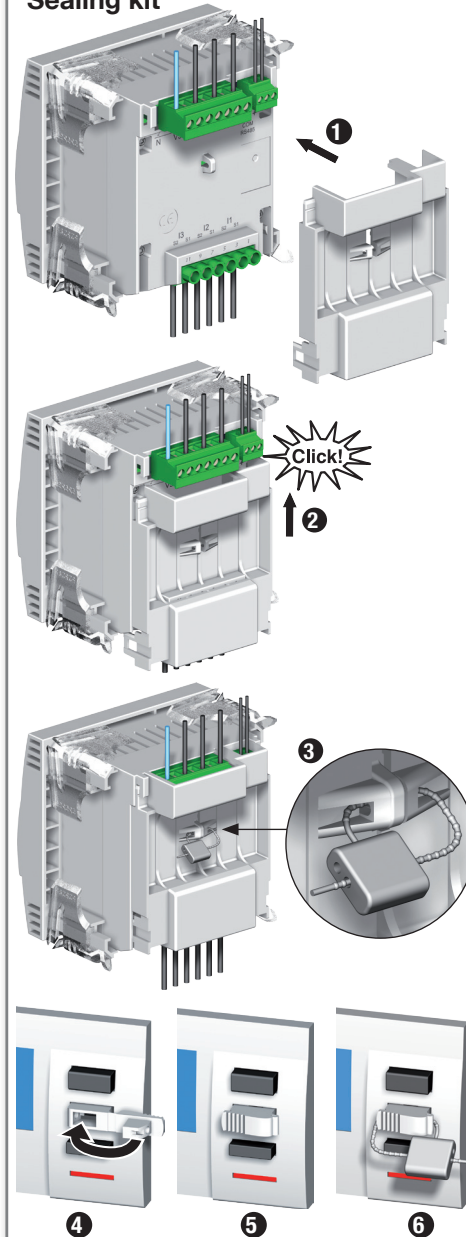

4

Device switch ON → Partial MAX Σ TL 1234N → UEr 103 → [5 3860]

Partial MAX Σ TL 1234N
COSφ MkvAvarh

3 sec. PROG

Current transformer
10, 25, ..., 2000, 2500A
OK

Network list
1bL, 2bL, 3bL, 3nBL, 4bL, **4nBL**

Modbus address
1, 2, ... **5**, ..., 253, 254
Add 5

Baud rate
4800, **9600**, 19200, 38400
bd 9600

Parity
no, odd, even
PAR no

Stop bit
1, 2
Stop 1

Reset
Max 41, Max P, Max Q, Max S, Max cosφ, Partial Ea+, Partial Ea-, Partial Er-
rst 41

3 sec. PROG = end of programming

Total Ea+ Σ T 1 92.46 kW h
Total Er+ Σ 92.46 k varh
Total Ea- Σ 92.46 kW h
Total Er- Σ 92.46 k varh
Partial Ea+ T 1 92.46 kW h
Partial Er+ 92.46 k varh
Partial Ea- 92.46 kW h
Partial Er- 92.46 k varh

Instantaneous current per phase (L1, L2, L3, LN)
L1 123.45 A
MAX L1 201 k A

Max current per phase (L1, L2, L3, LN)
L12 392.78 V

Voltage phase to phase, phase to neutral (L1-2, L2-3, L1-3, L1, L2, L3)

Frequency
F 50.03

Instantaneous 3 phases power (Σ):
- active power (kW) 579.23 kW
- reactive power (kvar) k var
- apparent power (kVA) kVA

Max 3 phases power (MAX Σ):
- active power (kW) 579.23 kW
- reactive power (kvar) k var
- apparent power (kVA) kVA

Min 3 phases power (- MAX Σ):
- active power (kW) 579.23 kW
- reactive power (kvar) k var

Instantaneous 3 phases cos φ (Σ)
Max 3 phases cos φ (MAX Σ) COSφ
Min 3 phases cos φ (- MAX Σ) COSφ