

Photovoltaic fuses

gPV curve

10 to 600 A, up to 1000 VDC



The solution for

- > Photovoltaic protection



Strong points

- > High breaking capacity up to 1000 VDC
- > Product designed for photovoltaic systems
- > Increased reliability
- > Improved safety

Extended range

- > Range of switches and sockets, combs and dedicated connection accessories

Compliance with standards

- > IEC 60269-6
- > IEC 60269-1
- > IEC 60269-2



Function

SOCOMEC's **gPV fuses** protect photovoltaic systems against overcurrents caused by the reverse currents that these systems can generate.

Advantages

High breaking capacity

Up to 50 kA at 1000 VDC.

Product designed for photovoltaic systems

Operating ranges adapted to low overcurrents specific to photovoltaic systems.

Increased reliability

- Absolute protection over time guaranteed by the simplicity of manufacture and function (Joule effect).
- No degradation of fuse characteristics over time.

Improved safety

The energy released whilst eliminating the fault (fuse blowing) is contained within the cartridge (no degassing).

What you need to know

Characteristics used

- I_{SC} : short circuit current of the string.
- $I_{SC\ MAX}$: short circuit current of the string due to maximum sunlight intensity.
- I_{RM} : maximum permitted reverse current.
- I_n : rating or nominal current of the fuse (25 °C in an RM socket).
- N_c : number of strings in parallel.
- U_g : fuse's maximum operating voltage.
- $U_{OC\ MAX}$: maximum open circuit voltage in the lowest temperature conditions.

When to protect

A PV string requires overcurrent protection when its own maximum admissible reverse current characteristic (I_{RM}) is less than the current generated by the rest of the installation (current generated by the other "Nc-1" strings).

How to protect

Protecting from overcurrents involves ensuring that both polarities are functionally grounded whether the DC is connected or not.

How to choose the right fuse protection

Voltage

$$U_e > U_{OC\ MAX}$$

Unless indicated otherwise, use $U_{OC\ MAX} = 1.2 U_{OC}$

Determining the fuse rating

Determining the fuse rating involves choosing a fuse that can:

- Withstand, without blowing, normal overcurrents during sunlight hours and the ambient temperature of the enclosure in which the fuse is installed, $I_n > I_{SC\ MAX}$ Unless indicated otherwise $ISC\ MAX = 1.4 I_{SC}$
- Melt reliably before the modules are damaged by the reverse current. $I_n < I_{RM}$

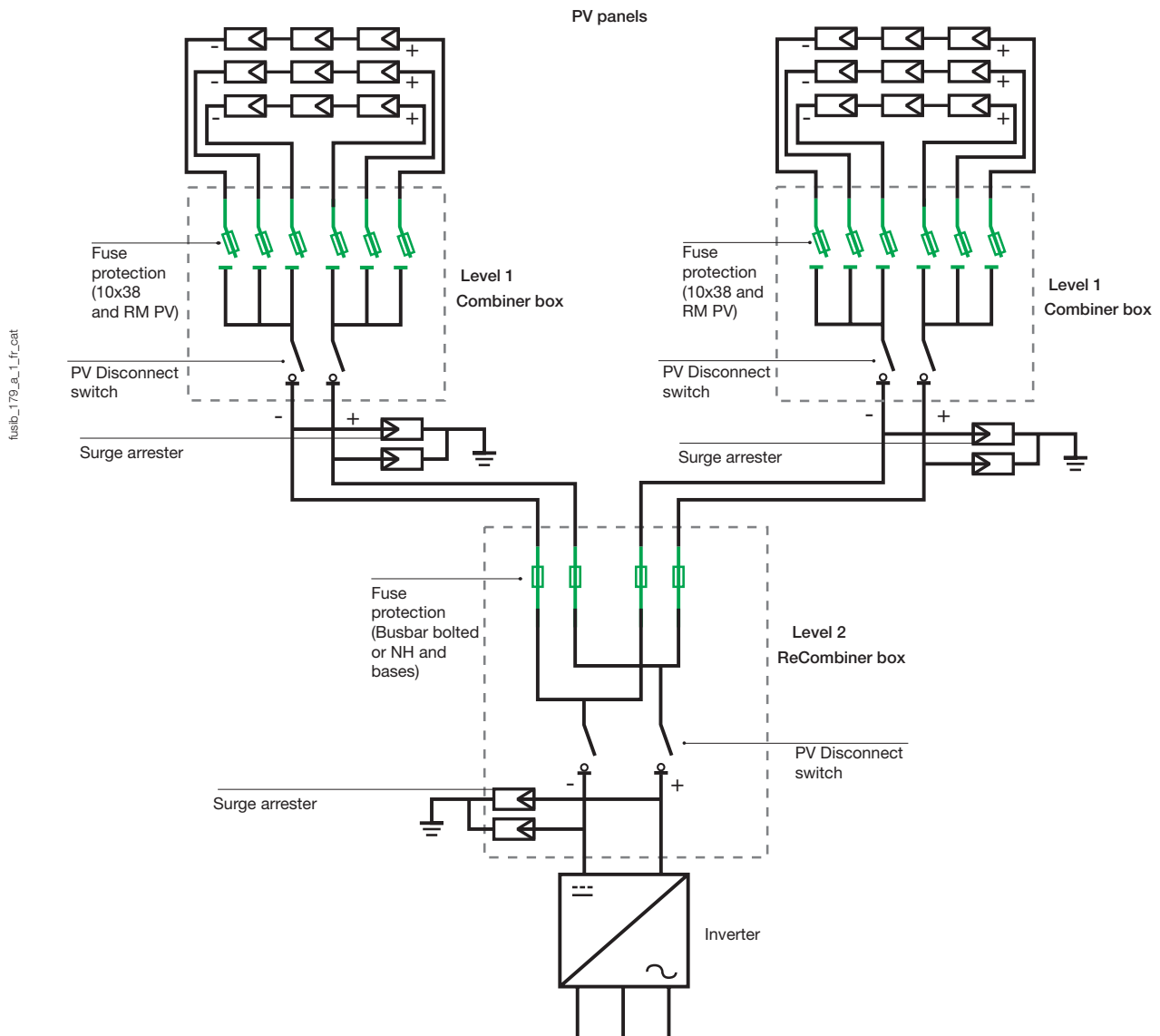

Photovoltaic fuses

gPV curve

from 10 to 600 A, up to 1000 VDC

References

Rated voltage 1000 VDC

Rating (A)	Fuse size	Dissipated power		Breaking capacity	Reference
		W @ In	W @ 0.8 In		
gPV cylindrical fuses					
10	10 x 38	2.58	1.51	30 kA	60PV 0010
12	10 x 38	2.61	1.42	30 kA	60PV 0012
15	10 x 38	2.44	1.08	30 kA	60PV 0015
16	10 x 38	2.70	1.56	30 kA	60PV 0016
20	10 x 38	2.99	1.75	30 kA	60PV 0020
gPV knife blade fuse					
32	NH1	8.5	4.3	50 kA	60PV 0032
40	NH1	9	4.6	50 kA	60PV 0040
50	NH1	10.5	5.4	50 kA	60PV 0050
63	NH1	12	6.1	50 kA	60PV 0063
80	NH1	15.5	7.9	50 kA	60PV 0080
100	NH1	16.5	8.4	50 kA	60PV 0100
125	NH1	17.5	8.9	50 kA	60PV 0125
160	NH1	24	12.2	50 kA	60PV 0160
200	NH1	25	13	50 kA	60PV 1200
250	NH2	35	23	50 kA	60PV 1250
315	NH3	44	27	50 kA	60PV 1315
400	NH3	50	30	50 kA	60PV 1400
500	3 L	85	50	50 kA	60PV 0500
600	3 L	118	92	50 kA	60PV 0600

Accessories

Accessories	Size NH1 Reference	Size NH2 Reference	Size NH3 Reference	Size 3L Reference
Fuse blown auxiliary contact	56PV 9901	56PV 9901	56PV 9901	56PV 9901
Fuse base recommended	65PV 1011	65PV 1002	65PV 1003	65PV 1113

Adjustment due to ambient temperature

$$I_{nf} = I_{scgen} / K_t$$

I_{nf} - gPV fuse rated current.

I_{scgen} - short-circuit current of PV generator in STC conditions.

K_t - correction factor.

Max. ambient temperature (°C)	Kt: correction factor
20	1
40	0.92
45	0.90
50	0.87
55	0.85
60	0.82
65	0.79
70	0.76

Standard dimensions (mm) as per IEC 60269-2

gPV cylindrical fuses

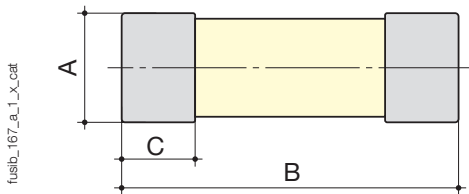

Fuse size	Striker	A	B	C
10 x 38	Without	10.3	38	10.5
14 x 51	Without	14.3	51.5	10.10
10 x 85	Without	10.3	85	10.5

gPV knife edge fuse

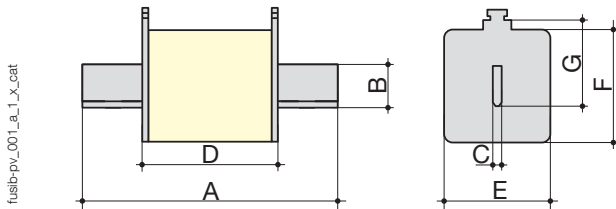

Fuse size	Striker	A max	B	C	D max	E max	F max	G
NH1	Without	137	20	6	68	40	53	40
NH2	Without	152	25	6	75	60	61	48
NH3	Without	152	32	6	75	70	75	60
1XL	Without	190	20	6	128	51	51	40
3L	Without	205	32	6	123	74	74	60

Photovoltaic fuses

gPV curve

from 10 to 600 A, up to 1000 VDC

Time/current operational characteristics

Rated voltage 1000 VDC

gPV cylindrical fuses 10x38

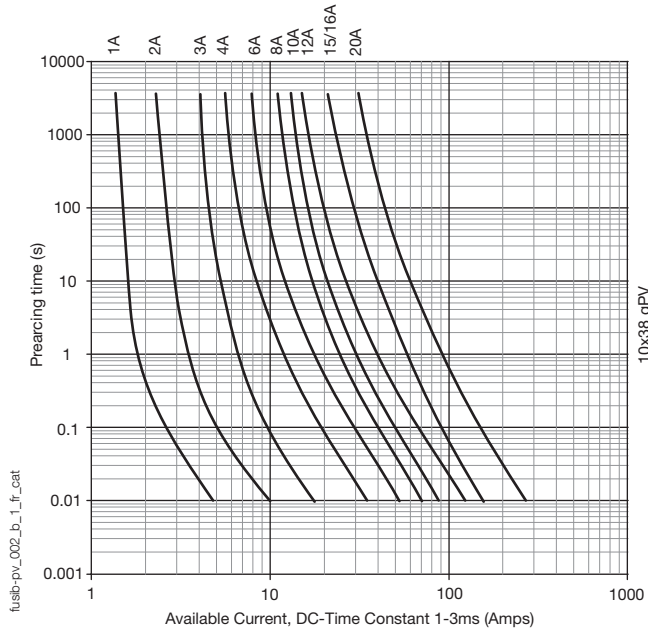

gPV cylindrical fuses 14x51

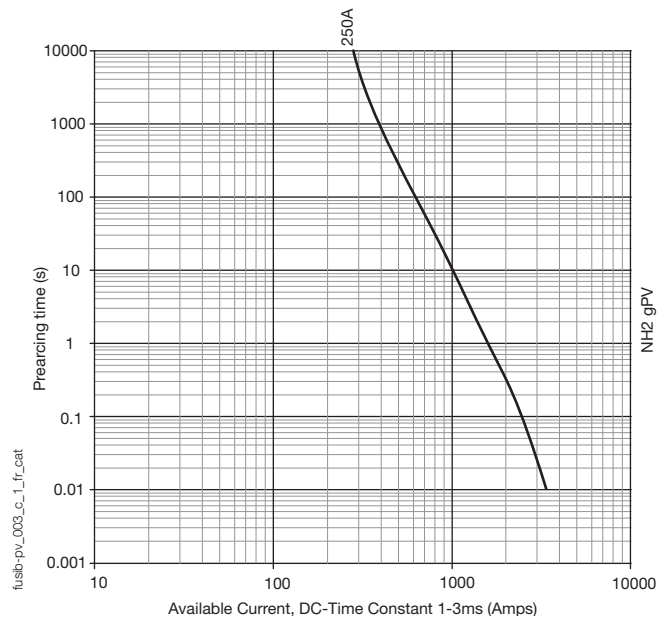

gPV NH1 knife blade fuses

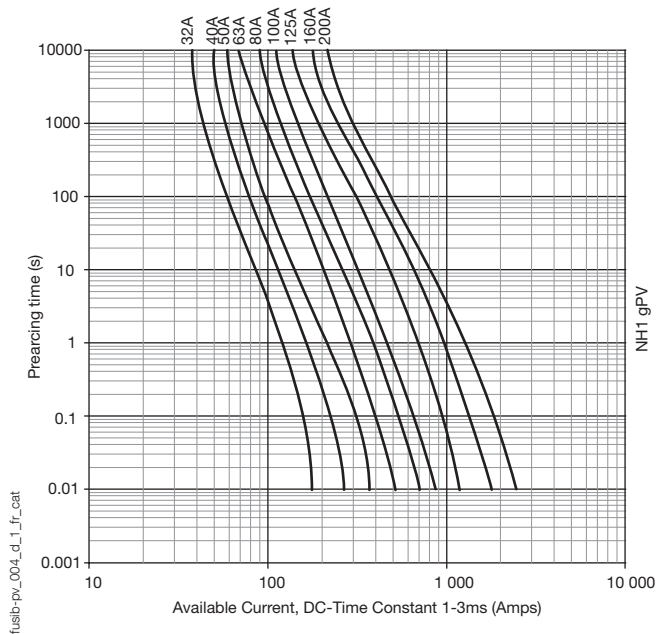

gPV NH2 knife blade fuses

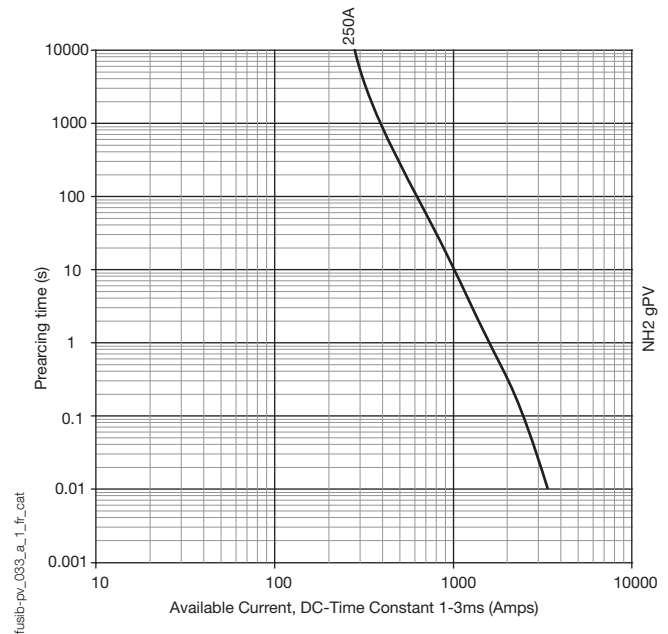

Rated voltage 1000 VDC (continued)

gPV NH3 knife blade fuses

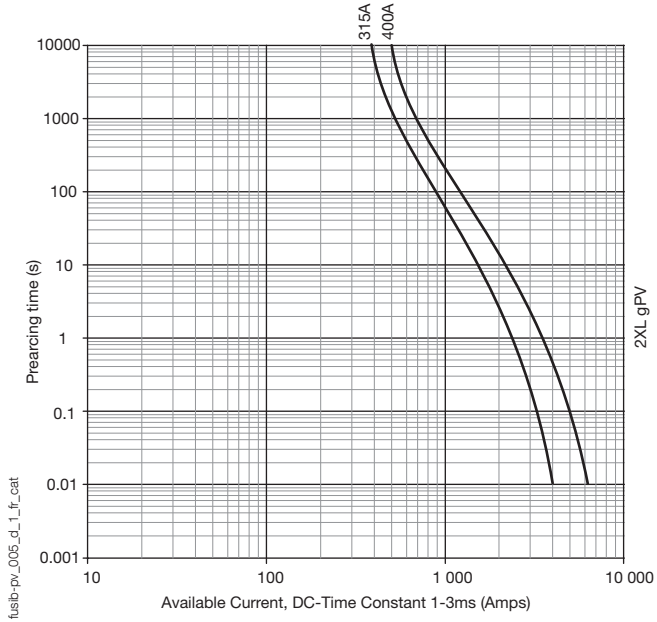

gPV 3L knife blade fuses

