

STATYS

200 - 1800A Cabinet and Integrable Frame



Socomec Resources Center
To download, brochures, catalogues
and technical manuals

INDEX

1.	WARRANTY CERTIFICATE	2
2.	SAFETY PROCEDURES	3
	2. 1. FOREWORD	3
	2. 2. PRECAUTIONS	3
	2. 3. ELECTRICAL RISK	3
	2. 4. RISK OF POWER CUT	3
3.	THE ROLE OF STATYS	4
4.	OPERATING PRINCIPLE	4
5.	OPERATING MODES	5
	5. 1. MANUAL TRANSFER	5
	5. 2. AUTOMATIC TRANSFER	5
	5. 3. ADVANCE TRANSFER SWITCHING MANAGEMENT (ATSM)	6
	5. 4. AUTOMATIC RESTART FUNCTION	6
	5. 5. OVERLOAD OPERATION	6
6.	FUNCTIONAL DIAGRAMS	7
7.	MIMIC PANEL	8
	7. 1. PRESENTATION	8
	7. 2. MEANING OF LEDS	9
	7. 3. PASSWORD MANAGEMENT	9
	7. 4. KEYPAD	10
	7. 5. DISPLAY	11
	7. 6. OPERATING MODES	12
	7. 7. STATYS SETTINGS	15
	7. 8. ALARM MANAGEMENT	17
8.	TOUCHSCREEN	18
	8. 1. DISPLAY DESCRIPTION	19
	8. 2. MENU ARCHITECTURE	20
	8. 3. FUNCTIONING MODE	21
	8. 4. STATUS	21
	8. 5. ALARMS MANAGEMENT	22
	8. 6. SYNOPTIC ANIMATION	23
	8. 7. EVENT LOG PAGE	24
	8. 8. MENU FUNCTION DESCRIPTIONS	25
	8. 9. ADDITIONAL USER FUNCTIONS	27
	8. 10. STS SETTINGS	28
9.	COMMISSIONING	29
	9. 1. START CONDITIONS	29
	9. 2. POWER-UP OF STATYS	29
	9. 3. SELECTING THE PREFERRED SOURCE	29
	9. 4. LOAD SUPPLY	29
	9. 5. TRANSFER ONTO "MAINTENANCE BYPASS"	29
	9. 6. "MAINTENANCE BYPASS" RETURN	30
10.	COMMUNICATION INTERFACE	30
11.	ADVANCED DIAGNOSTICS AND PARAMETERS	30

1. WARRANTY CERTIFICATE

The warranty terms and conditions are stipulated in the offer, by default the following clauses apply.

The SOCOMEC warranty is strictly limited to the product(s) and does not extend to equipment which may be integrated with this/these product(s), nor the performance of such equipment.

The manufacturer guarantees its products to be free from manufacturing faults and defects in design, material or workmanship, subject to the limits set forth below.

The manufacturer reserves the right to modify the delivery with a view to fulfilling these guarantees or to replace defective parts. The manufacturer's warranty does not apply in the following cases:

- fault or defect in the design of parts added or supplied by the customer
- fault due to unforeseen circumstances or force majeure
- replacement or repair resulting from normal wear and tear of the modules or machinery
- damage caused by negligence, lack of proper maintenance or misuse of the products
- repair, modification, adjustment or replacement of parts undertaken by unqualified third parties or personnel without the express consent of SOCOMEC

The warranty period is twelve months commencing from the date of delivery of the product.

The repair, replacement or modification of the parts during the warranty period does not imply or justify any extension of the warranty beyond the original period.

In order to establish a valid warranty claim, the purchaser must notify the manufacturer in writing immediately after the discovery of any apparent material defects and provide any and all supporting evidence of the defects at the latest within eight days before the date of expiry of the warranty.

Defective parts which have been returned and replaced free of charge shall become the property of SOCOMEC.

The warranty is void if the purchaser has undertaken modifications or repairs on the devices on his or her own initiative and without the express consent of the manufacturer.

The manufacturer's responsibility is strictly limited to the obligations defined in this warranty (repair and replacement) excluding any other right to claim compensation or indemnity.

Any import tax, duty, fee or charge of any nature whatsoever imposed by European regulations or those of an importing country or of a transit country shall be paid by the purchaser.

2. SAFETY PROCEDURES

2. 1. FOREWORD

Thank you for choosing the STATYS Static Transfer System from SOCOMEC.

This equipment complies with the IEC 62310-2 product standard concerning Static Transfer Systems (STS).

This equipment conforms to the EC directives applicable to this type of product. This conformity is indicated by the CE mark:



2. 2. PRECAUTIONS

For connection of STATYS, refer to the installation notice.

Carefully read this manual before operating STATYS.

CAUTION

For optimal use, it is recommended to maintain the ambient temperature and humidity at the values specified by the manufacturer.

DANGER



When in shutdown mode, a STS remains powered by supplies at the input of each of the two sources.

2. 3. ELECTRICAL RISK

In normal operating conditions, there is no danger for personnel handling this equipment.

WARNING

All operations and maintenance must be performed by authorised personnel who have undertaken suitable training.

Scrupulously follow the operating or maintenance instructions described in this manual.

Take maximum precautions and determine which parts are live:

- by following the load diagrams,
- by checking the presence of potential with a voltmeter, for example.

2. 4. RISK OF POWER CUT

WARNING

Scrupulously follow the operating instructions described in this manual to prevent inadvertent power cuts which may pose a safety hazard to the user.

3. THE ROLE OF STATYS

The role of STATYS is to monitor the alternate source, to detect any failure of the preferred source and, if this should occur, to ensure that the load is automatically transferred to the alternate source.

4. OPERATING PRINCIPLE

STATYS is an autonomous electrical device which permits the seamless transfer of the load between a preferred electrical source and another alternate, synchronous or unsynchronous source (see functional diagram § 6).

Under normal operation, STATYS supplies the load from the preferred source. S1 or S2 can be selected as the preferred source by the user, according to on-site restrictions.

Two transfer modes are possible:

- manual transfer mode, controlled by the operator locally or remotely by means of a BMS or other communicating system
- automatic transfer mode, which occurs when an out-of-tolerance voltage is detected on the preferred source. The changeover is made without source overlap according to the Break-Before-Make principle.

NOTE: The preferred source (source 1 or source 2) is selected using the keyboard and this selection is displayed on-screen.

5. OPERATING MODES

5. 1. MANUAL TRANSFER

The user is able to control the transfer of the load from one source to another, both via the keypad and via communication (see "communication interface" § 10).

Manual transfer does not disturb the supply to the load.

If the synchronisation conditions are not met after 30 seconds (factory default setting), an asynchronous transfer occurs, if authorised, otherwise the request is cancelled.

If the transfer cannot take place (for example, 2nd source out of tolerance), the following icon appears:



Impossible transfer or



Note: The alarm will shut off automatically when normal conditions are restored.

5. 2. AUTOMATIC TRANSFER

Automatic transfer occurs in the event of a voltage drop, frequency drop or when the preferred source is unavailable. It does not interrupt the supply to the load. Automatic transfer switches the supply from the preferred source to the alternate source. Once the preferred source is re-established, the system automatically returns to this source after a time delay, which can be configured by the user.

The parameters that define the quality thresholds of the source and the automatic return can be adjusted in programming mode (see § 7.6.4 or 8.10)

To ensure totally secure transfer, STATYS continuously monitors the presence of the alternate source.

If the alternate source is unavailable (or if the voltage exceeds the preset tolerances), the transfer function is inhibited. STATYS raises an alarm to warn the operator that the transfer is no longer possible.

Automatic return from the alternate source back to the preferred source may also occur following a manual transfer.

In the event of a short circuit at the output of the supplied equipment, the transfer function is inhibited. This stops the short circuit from being transmitted along the other track and thus prevents the other source from being interrupted.

Two types of transfer may occur, synchronous or asynchronous, according to the source synchronisation status and the hardware configuration.

SYNCHRONOUS TRANSFER

Synchronous transfer occurs automatically when the two sources S1 and S2 are deemed to be synchronised, e.g. when their phase deviation is within the tolerance window (standard +/- 15°). In this case, switching the source does not alter the phase.

If the phase deviation exceeds this tolerance window, synchronous transfer is inhibited and automatic changeover to the other source will not be possible. However, the transfer may in any event be executed in these conditions if the system is configured for synchronous/asynchronous transfer.

NOTE: STATYS is configured for synchronous/asynchronous transfer by default.

It may be configured to “synchronous only” transfer for applications which are sensitive to phase shifts (advanced parameters, see §10).

Most information processing equipment, servers, computer... are impervious to significant phase variations.

However if a significant part of the load is composed by magnetic elements (typically when there is a transformer between STATYS and the loads) there is a risk of inrush in case of transfer. In this case ATSM fonction must be activated (ATSM fonction see 5.3).

ASYNCHRONOUS TRANSFER

Automatic asynchronous transfer occurs only if it is authorised by the software configuration (standard factory configuration, advanced parameters see §10) and if the sources S1 and S2 are not synchronised, e.g. their phase deviation exceeds the tolerance window. In this case, switching the source may produce a significant phase variation during the changeover.

This type of transfer allows for automatic load changeover between sources which are not permanently controlled, or which are unusually out of phase, thereby maximising the security of the power supply.

5. 3. ADVANCE TRANSFER SWITCHING MANAGEMENT (ATSM)

This function is dedicated to manage the startup and the transfer on downstream magnetic loads; typically when a transformer is placed between the STS and a critical load. In this case, there is a risk of high of transient current in case of transfer due to the magnetic load behavior. Here ATSM must be activated to avoid this high current to creat the risk to trip the upstream protection.

ATSM function works by limiting the transient output current (not activated by default). It measures the transformer magnetic flux and transfer each phase individually. Each phase is closed at the moment where the source voltage is matching the transformer flux. By doing so, the output current is not going higher than the nominal current of the load .

5. 4. AUTOMATIC RESTART FUNCTION

Following the total unavailability of both sources and if STATYS is in conduction state on one of the two sources, an automatic restart and conduction occurs on the return to one of the 2 sources.

The supply is re transferred automatically onto the preferred source as soon as this source becomes available.

The automatic restart function is configurable and is set to OFF by default.

5. 5. OVERLOAD OPERATION

The STATYS overload control is based on the principle of filling a reservoir more or less rapidly, depending on the measured load rate.

Each STATYS string has its own reservoir.

When STATYS is in overload, an “OVERLOAD ALARM” message appears and the “GENERAL ALARM” is triggered.

6. FUNCTIONAL DIAGRAMS

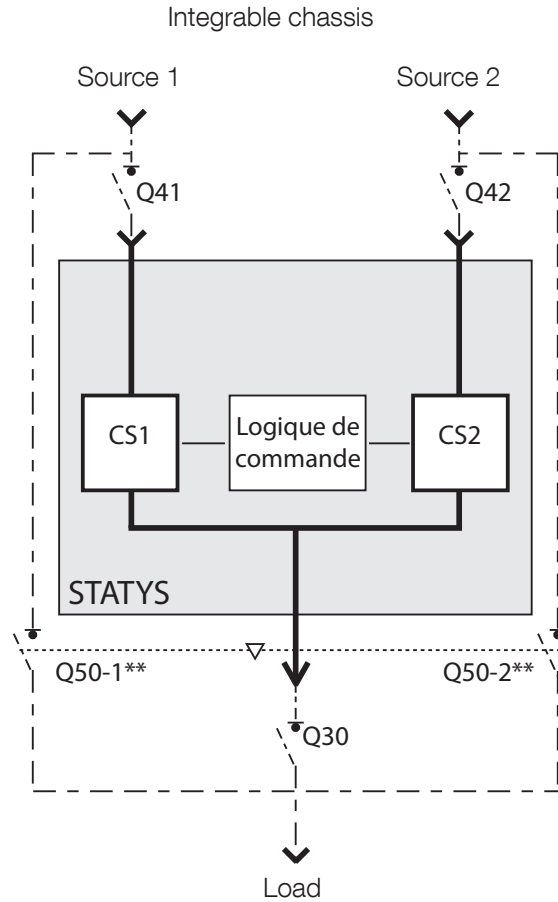
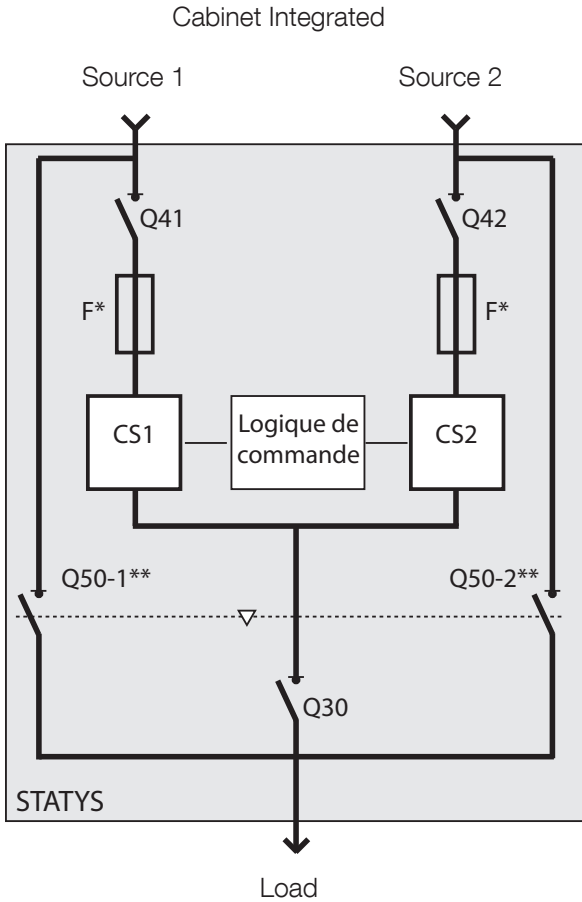

* = optional

** = Q51 and Q52 for STATYS 800/1000A

LEGENDS:

- Q41 = Source 1 input switch*,
- Q42 = Source 2 input switch*,
- Q30 = Output switch*,
- Q50 = Inverter, for source 1 or 2 maintenance bypasses*,
- CS1 = Static Switch 1,
- CS2 = Static Switch 2,
- F = Protection by Fuse (optional),

- - - and * = Supplied by customer in Integrable version.

7. MIMIC PANEL







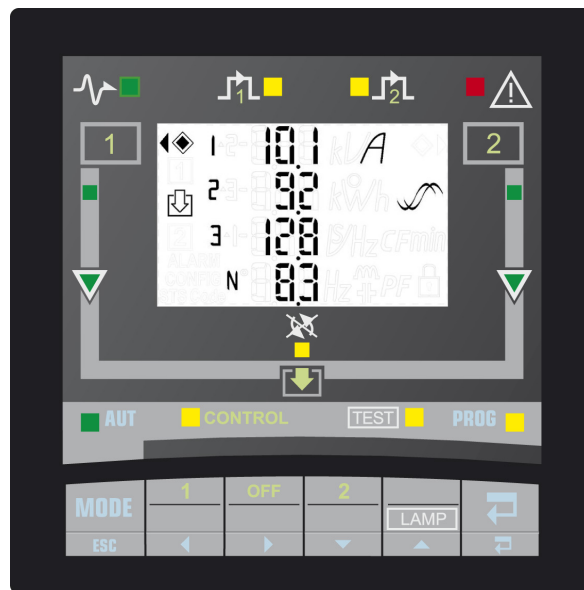



7. 1. PRESENTATION

The mimic panel consists of:

- an LCD screen permitting:
 - display of electrical magnitudes of an input or output (in AUT mode)
 - activation of system controls (in CONTROL mode)
 - display of maintenance codes (in TEST mode)
 - programming of the device (in PROG mode)
- 13 LEDS indicating:
 - the different operating states
 - the mimic panel showing the power flow
 - the system's current mode
- 6 keys used for system management.



7. 2. MEANING OF LEDS

	ON	BLINKING	OFF
	Load supplied by STATYS	Output shutdown imminent	Output not supplied by STATYS
	Output supplied directly by source 1	/	/
	Output supplied directly by source 2	/	/
	General Alarm	Critical alarm	No alarm active
	Source within tolerances	Source outside tolerated range	Source absent
	Conduction path	Path outside tolerated range	No conduction
	Transfer locked	Switchback impossible	Transfer possible
	Selected mode	Mode awaiting selection	/
			
			
			

7. 3. PASSWORD MANAGEMENT

Two levels of protection:



"User" password: provides access to control mode and user parameters settings (user access). Disabled by default (set to _ _ _), it can be configured from 000 to 999 and _ _ _.

"System" password: provides access to user and system parameter settings. The default setting is 000, it may be configured from 000 to 999.

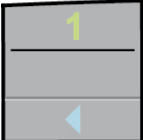
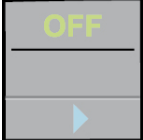
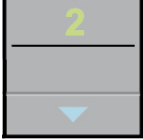
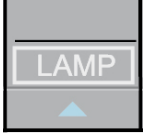

When the device is in standby mode, the password is invalidated.

7. 4. KEYPAD

KEY	FUNCTION
	Accesses different menus (AUT, CONTROL, TEST and PROG)
	Once in a menu, cancels an ongoing command
	In CONTROL mode, activates source 1 conduction
	Scrolls display, menu or digit
	In CONTROL mode, stops conduction
	Scrolls display, menu or digit
	In CONTROL mode, activates source 2 conduction
	Modifies the blinking value
	In TEST mode, launches a full display test (LEDs, screen, buzzer)
	Modifies the blinking value
	Acknowledges alarm
	Validate or store



The buzzer emits a short beep whenever a key is pressed

7. 5. DISPLAY

The LCD screen displays:

The following icons (irrespective of which mode is selected):

 or  = indicates the preferred source



Off = synchronous sources

Blinking = sliding sources

On = permanently asynchronous sources



= Password protection is ON

Electrical magnitudes:



Voltages and frequency of each source on 1 page marked with the number **1** or **2** to indicate the source in question

Voltages and frequency (1 page), current (1 page), power (kW and kVA), power factor and crest factor (CF) (1 page) and load rate (Lr and %) (1 page) of the output, marked with the icon 

If there is no output load, the display switches alternately from source 1 pages to source 2

If there is a load at the output, only the output pages are displayed

An alarm message may appear if an alarm is raised (see "alarm" chapter)

This standard display may be temporarily fixed on one page using the buttons  and 



The display goes into standby mode (backlight OFF) after 5 minutes of keypad inactivity.



7. 6. OPERATING MODES

there are 4 modes:

- automatic (AUT)
- control (CONTROL)
- test (TEST)
- programming (PROG)



Whatever the mode selected, STATYS operation remains prioritised.

Press the  key to select the next mode (the corresponding LED will blink), press the  key to enter the selected mode.



If the keypad is not touched for 30 seconds, the system returns to automatic mode.

7. 6.1. Automatic mode

This is the default mode. In this mode the LCD screen displays the electrical magnitudes of the inputs or of the output (see "display" chapter), as well as alarm messages (see "alarm" chapter).



The display can be fixed on one page using the keys  and .



7. 6.2. Control mode







This mode is accessed by entering the "user" password (if defined)

The display is identical to the automatic mode display (but cannot be fixed on one page). The device waits for the conduction state to be changed manually:

Stop conduction press the  (OFF) key, the "Id off" indicator blinks, press the  key to validate this choice or press the  key to cancel the command.

Activate source 1 conduction press the  key (1), the message "use S1" blinks, press the  key to validate this choice or press the  key to cancel the command.

Activate source 2 conduction press the  key (2), the message "use S2" blinks, press the  key to validate this choice or press the  key to cancel the command.



 **These changeovers are performed whether the sources are synchronous or asynchronous, unless the factory setting of the device is changed to "synchronous only" mode (no asynchronous transfer, settings accessible in advanced parameters, see §10).**

 **If the sources are sliding, the appliance requests a "transfer on the fly"**



Transfer on the fly



If, during a conduction activation request, the sources are sliding, a "fly" message blinks along with the source shift value.

The user can then:

- wait for the transfer to occur automatically once the 2 sources become synchronous,
- cancel using the  key and thereby return to the "fly" message,
- or force the transfer (if the device configuration authorises an asynchronous transfer) by once more pressing the key for the desired source. The message "frc trf" (force transfer) blinks on the last line ("fly" no longer blinks), press the  key to validate the forced transfer request.

To exit this mode, press the key for the source in conduction state once more. The message "esc" then appears.

Validate it using the  key or cancel it using the  key.

Stop automatic switchback when the device is waiting for phase synchronisation, press the key for the alternate source ( or ).

The message "end asb" appears

7. 6.3. Test mode

This mode enables maintenance codes to be displayed in the form of pages marked with a number

For each maintenance page the following information appears:

- on the bottom line, the message "STS Code N° xxx" where xxx corresponds to the page n°,
- on the top two lines, 4 hexadecimal digits corresponding to the maintenance code.

the page is changed using the keys  and 

Pressing on the  key launches a complete mimic panel test by:

- Switching on all LEDs,
- Displaying all LCD segments,
- Operating the buzzer.



This mode does not interrupt the normal operation of STATYS

7. 6.4. Programming mode



This mode is accessed by entering a password:

If the "user" password is inputted, only "user" parameters may be configured.

If the "system" password is inputted, all parameters could be modified.

Choice of preferred source (user access)

Display: PS

Default value: S1

Possible choice: S1 or S2

Modbus link configuration (user access)

Display: mod bus

Slave number

Display: sla nb

Default value: 1

Possible choice: 1 to 255

Link speed

Display: bds

Default value: 9600

Possible choice: 2400, 4800, 9600 or 19200

Link parity

Display: par

Default value: no

Possible choice: odd, eve (even) or no

Timestamp (user access)

Display: day time

Date

Display: day

Default value: current day

Possible choice: day-month-year with day from 1 to 31, month from Jan to Dec and year from 00 to 99

Time

Display: time

Default value: actual hour

System configuration (System access)

Display: sys cfg

Password configuration

Display: pin code

User password

Display: usr pin (user pin)

Default value: _ _ _

Possible choice: 000 to 999 (000 = no password)

System password

Display: sys pin (system pin)

Default value: 000

Possible choice: 000 to 999

Remote control (System access)

Display: rem ctl (remote control)

Default value: en

Possible choice: en (enable) or dis (disable)

7. 7. STATYS SETTINGS

Nominal voltage (System access)¹

Display: un (Un)

Default value: nominal value measured by the equipment

Possible choice: 100V to 499V

Nominal frequency (System access)¹

Display: fn (F)

Default value: nominal value measured by the equipment

Possible choice: 50 or 60 Hz

¹Values used to calculated upper and lower limits.

Sensitivity threshold* (System access)

Display: sen (sensitivity)

Default value: std

Possible choice: L for “low”, std for “standard”, H for “high” and cus for “custom” (configuration via PC link)

*Values used to carry out transfer (if authorised):

Low Sensitivity:

- the RMS voltage value exceeds the rated value by +/- 15%,
- The frequency exceeds the rated value by +/- 4 Hz,
- instantaneous voltage (1ms transient) drops to 40% below the RMS rated voltage.

High Sensitivity:

- the RMS voltage value exceeds the rated value by +/- 5%,
- The frequency exceeds the rated value by +/- 1 Hz,
- instantaneous voltage (1ms transient) drops to 15% below the RMS rated voltage.

Standard Sensitivity:

- the RMS voltage value exceeds the rated value by +/- 10%,
- The frequency exceeds the rated value by +/- 2 Hz,
- instantaneous voltage (1ms transient) drops to 25% below the RMS rated voltage.

Automatic restart (System access)

Display: aut on (automatic on)

Use of automatic restart

Display: aut on (automatic on)

Default value: no

Possible choice: yes or no

Delay before automatic resupply

Display: dly (delay)

Default value: 0 seconds

Possible choice: 0 to 65535 (if aut on = yes)

Automatic switchback to the preferred source (System access)

Display: aut sb (automatic switchback)

Use of automatic switchback

Display: aut sb (automatic switchback)

Default value: no

Possible choice: yes or no

Delay before automatic switchback

Display: dly (delay)

Default value: 3 seconds

Possible choice: 0 to 65535 (if aut sb = yes)

7. 8. ALARM MANAGEMENT

When an alarm is triggered (see alarms table), a flashing message (and his number) appears on the screen regardless of which mode is in use. If the alarm is critical the LED flashes, otherwise it is lit continuously. In addition to the message and the LED warning, a buzzer will sound.

When the  key is pressed, the alarm is acknowledged and the buzzer is silenced, the display remains fixed (it shows the display pages) but the LED remains ON

These different alarm displays will disappear when the alarm disappears.

In the case of multiple alarms, only the most important one will be displayed and the buzzer will sound until the last alarm is acknowledged.

Name	Message	N°	Meaning
Imminent stop	imm stp	0	Imminent conduction shutdown
Output Isc detection	out isc	1	Output in short circuit
Manual Bypass	mnt bp	2	Manual bypass on
Overload	l max	3	Overload at the output
Consecutive detections	con det	5	Too many consecutive transfers
Auto re transfer impossible	sb imp	6	Impossible Switchback
Transfer impossible	trf imp	7	Impossible Transfer
Power Path 1 deteriorated	pa1 at	9	Input 1 out of tolerance
Power Path 1 in short circuit	pa1 sc	10	Input 1 in short circuit
Power Path 1 in failure	pa1 out	11	Input 1 in failure
Power Path 2 deteriorated	pa2 at	13	Input 2 out of tolerance
Power Path 2 in short circuit	pa2 sc	14	Input 2 in short circuit
Power Path 2 in failure	pa2 out	15	Input 2 in failure
Backfeed S1 protection open	bf opn	16	Source 1 protection open
Backfeed S2 protection open	bf opn	17	Source 2 protection open
Ambient temperature max	tmp max	18	Max temperature reached
Preventive alarm	pre alm	25	Preventive alarm
Configuration alarm	cfg alm	26	Problem with the settings and parameters
Control Panel alarm	hmi alm	27	Communication with screen lost
Electronic	eln	28	Electronic problem
Custom input alarm	cus in	29	Custom alarm
Maintenance alarm	mnt alm	30	Maintenance alarm
General Alarm	gen alm	31	General Alarm

8. TOUCHSCREEN

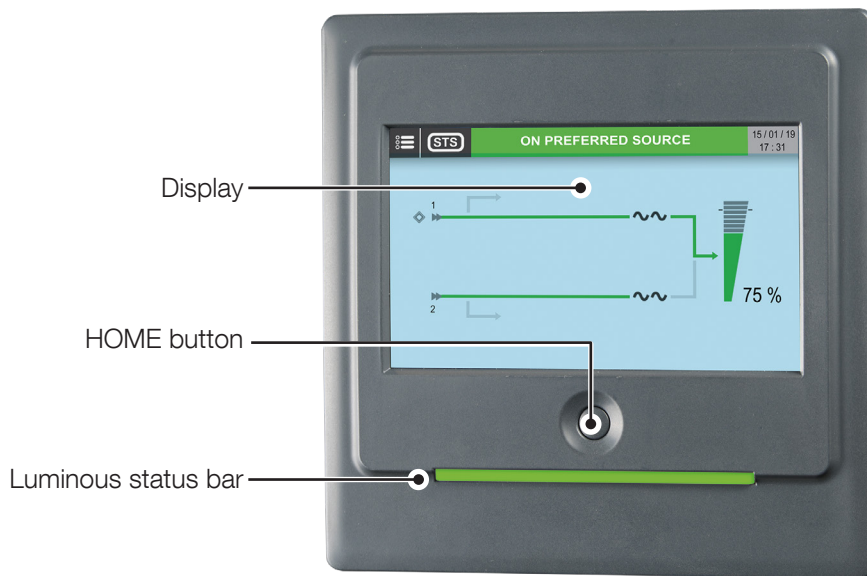

Control panel with LED status bar indicator	
Colour	Description
Flashing red-yellow-green-red	No communication. The data is no longer updated or not present. Load status cannot be given.
Flashing red	Load supplied, but the output will stop in few minutes.
Red	Load not supplied: Output switched OFF due to an alarm.
Flashing yellow-red	Load supplied, but no longer protected. A critical alarm occurs.
Flashing yellow	Maintenance requested / or service mode in progress.
Yellow	Load supplied with warning or load on alternate Source.
Green	Load on preferred Source.
Grey (OFF)	Load not supplied.

Only two elements are necessary to interact with the unit:

- HOME button: is a mono-stable button used to interact manually with the display especially in emergency situations. Logic behind the interaction is:
 - Single pressing (below 3 sec): HOME page return of graphic display
 - 3 sec < time < 6 sec: change the language to the default (English)
 - 6 sec < time < 8/9 sec: go to the calibration screen automatically
 - Above 8/9 sec: implement the hw reset of the micro controller and restart of the graphic
- Display: is the main active matrix of the display sensitive to touch pressure. The display is designed for rugged industrial applications. The display is single-touch only (no double touch effects). Depending on pressure, the navigation tree and various functions will be executed.

Two special functions are present on the control panel:

- Standby screen: for safety reasons, after a programmable amount of time, the display goes on standby. Display goes to the main screen and touch screen sensitivity is disabled. A label on the bottom of the main screen displays this status. To exit this status press the screen for the HOME button.
- OFF status: for power consumption and life enhancement, after a programmable amount of time display goes in "off". Display goes black and no interaction is possible. Touching the HOME button or screen resumes normal operations.



Handle the control panel with care. It is made of metal, glass and plastic and contains delicate electronic components. The control panel may be damaged if dropped, pierced or broken or comes into contact with liquids. Do not use the control panel with a cracked screen, as it may cause injury.

8. 1. DISPLAY DESCRIPTION

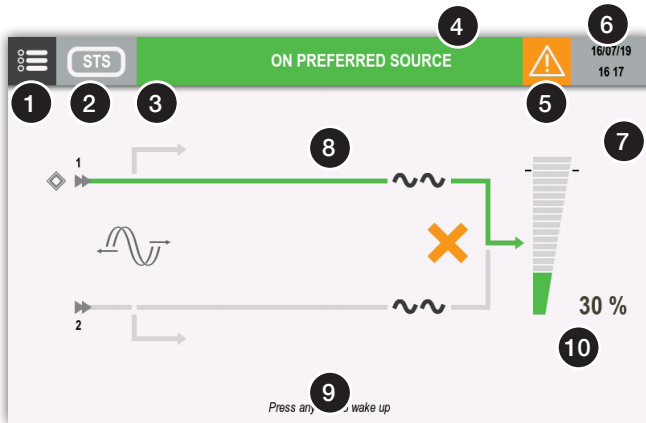

1	Menu access
2	Device reference
3	Functioning mode (see 'Functioning mode' chapter)
4	Status displaying / Status page access
5	Alarm present – access to alarm page “Alarms” icon appears in case of preventive/critical alarm. A dedicated pop-up appears and can be cleared.
6	Clock
7	Maintenance alert
8	Synoptic area
9	Help message area “Press Key to wake up” appears when the display goes on standby. Touch the display to wake it up.
10	Measures report

8. 2. MENU ARCHITECTURE

MONITORING

▶ ALARMS

▶ STATUS

▶ SYNOPTIC

EVENTS LOG**MEASUREMENTS**

▶ OUTPUT MEASUREMENTS

▶ SOURCE 1 MEASUREMENTS

▶ SOURCE 2 MEASUREMENTS

CONTROLS

▶ TRANSFER

▶ SWITCH ON PREFERRED SOURCE

▶ SWITCH ON ALTERNATE SOURCE

▶ FORCE ASYNCHRONOUS TRANSFER

▶ ABORD ONFLY TRANSFER

▶ SOURCE

▶ SET S1 AS PREFERRED SOURCE

▶ SET S2 AS PREFERRED SOURCE

▶ SUBSET

▶ SWITCH ON S1

▶ SWITCH ON S2

▶ SWITCH LOAD OFF

▶ MAINTENANCE

▶ ALARMS RESET

▶ LED TEST

CONFIGURATIONS

▶ CLOCK

▶ COM-SLOTS

▶ COM-SLOT 1

▶ REFERENCE

▶ SOCOMEC REFERENCE

▶ SERIAL NUMBER

▶ REMOTE

▶ REMOTE ON

▶ REMOTE OFF

USER PARAMETERS

▶ LANGUAGE

▶ PASSWORD

▶ BUZZER

▶ DISPLAY

▶ PREFERENCES

▶ TOUCHSCREEN

SERVICE

▶ SERVICE REPORT

▶ FIRMWARE VERSIONS

▶ SETTINGS

▶ NETWORK PARAMETERS (Only for service)

▶ MAINTENANCE CODE

8. 3. FUNCTIONING MODE



Service

8. 4. STATUS

8. 4.1. Status page

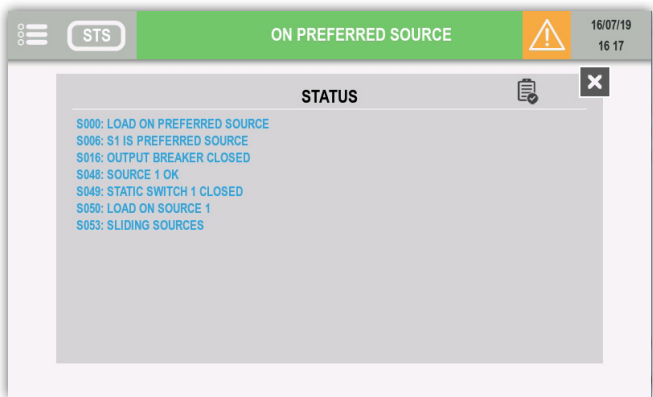

Filtering	
	List all active status
	List all status
	List all status not active

8. 5. ALARMS MANAGEMENT

8. 5.1. Alarm report

The alarm icon is present if at least one alarm is present.

Tap on the icon to open the alarm list.

8. 5.2. Alarm popup

In case of critical alarm a popup message appears and the buzzer is running according its settings.

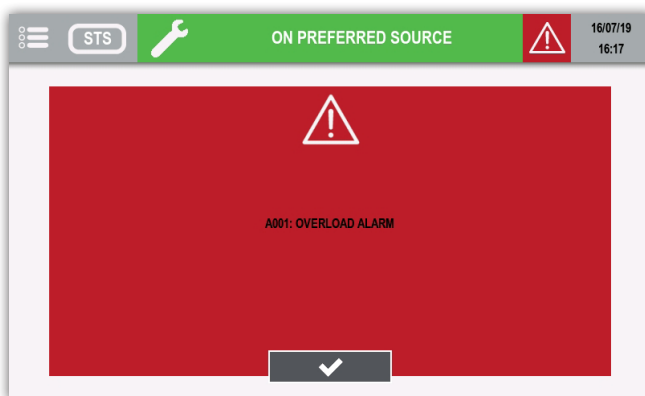

The highest priority alarm is displayed.



Tap on valid button to stop the buzzer and to close the popup message. The alarm page is automatically display after this action.

8. 5.3. Alarm page













Filtering	
	List all active alarms
	List all active preventive alarms
	List all active critical alarms

POPUP ALARM FOR PREVENTIVE ALARM

In USER PARAMETERS menu, USER PREFERENCES item gives the possibility to enable popup alarm also with preventive alarms.

8. 6. SYNOPTIC ANIMATION

Item	Description	Rules of animation				Touch actions
		Grey	Green	Yellow	Red	
1	Preferred source	-	-	-	-	-
2	Maintenance bypass 1	Present	-	Load on maintenance bypass	-	-
3	Input source 1	voltage absent	voltage presence	Out of tolerance	-	-
4	Static Switch 1	Normal status	-	Preventive alarm	Critical alarm	Access to Static Switch page
						
5	Load rate symbol	No load	Fill-up to 95%	Fill-up to 110%	Fill-up over 110%	Access to output measurements pages
						
6	Load rate value	Instantaneous value. displayed if value > 0				-
7	Maintenance bypass 2	Present	-	Load on maintenance bypass	-	-
8	Input source 2	voltage absent	voltage presence	Out of tolerance	-	-
9	Static Switch 2	Normal status	-	Preventive alarm	Critical alarm	Access to Static Switch page
						

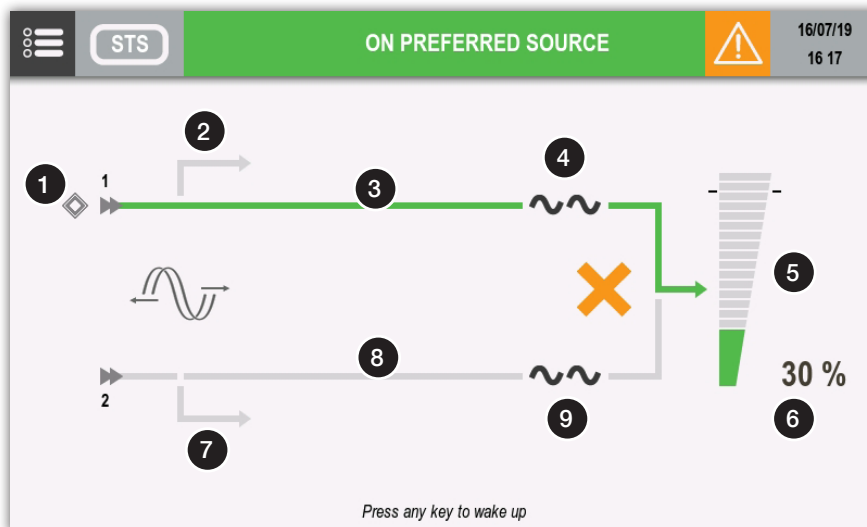

8. 6.1. Additional icons



Transfer impossible



Transfer locked



Maintenance alarm.
Preventive maintenance is requested.

8. 7. EVENT LOG PAGE

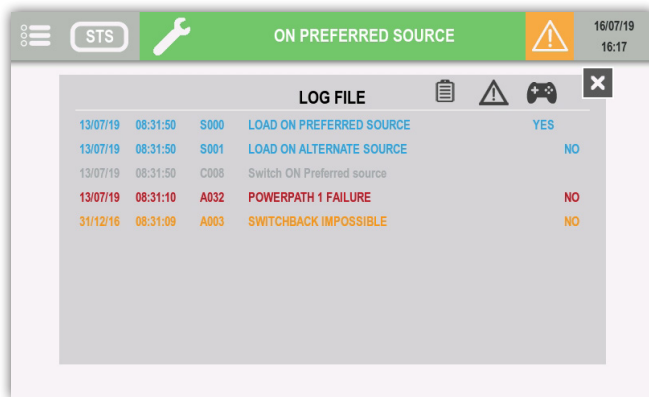

	Show STATUS events
	Show ALARMS events
	Show CONTROLS

8. 8. MENU FUNCTION DESCRIPTIONS

8. 8.1. Entering passwords

Some operations and settings require a password in order to be performed.

Press ENTER to confirm the selection or HOME BUTTON to abort.

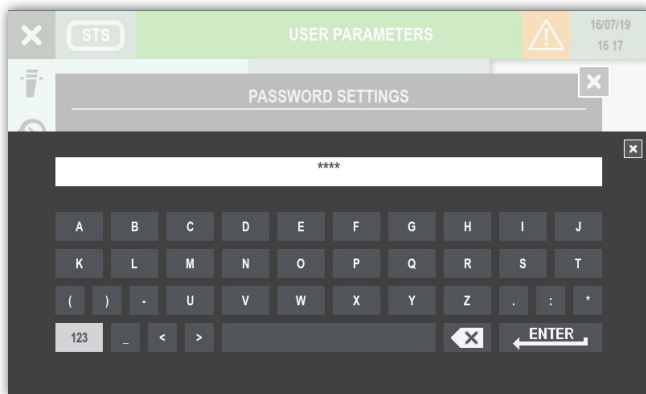

Press “123” to cycle to number view page.

Press ENTER to confirm.

8. 8.2. MONITORING menu

Submenu Alarm opens the alarm pages.

Submenu Status opens the status pages.

8. 8.3. EVENTS LOG menu

This menu accesses the event log (Status and Alarms).

8. 8.4. MEASUREMENTS menu

This menu displays all STS measurements relating to the input stages, output stage.

The pins on the bottom of the screen indicate whether or not there are more pages. Sliding to the right or left changes measurements page.

8. 8.5. CONTROLS menu

This menu contains the commands that can be sent to the STS. Some of them are password protected.

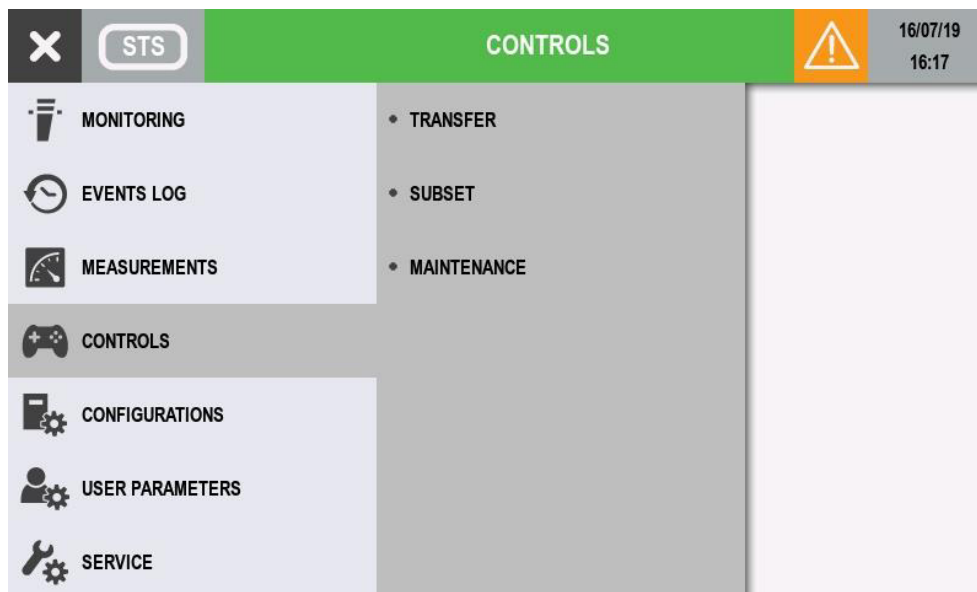

TRANSFER:

- Switch ON preferred or alternate source
- Force or Abort asynchronous Transfer

SUBSET:

- Load ON source 1 or 2
- Switch load OFF

MAINTENANCE:

- reset alarm

8. 8.6. STS CONFIGURATION MENU

- CLOCK: this function sets the date and time.
- COM-SLOTS: this function configures the RS485 modbus serial link.
- REFERENCE: STATYS identification and serial number.
- REMOTE: this function enables controls from remote devices through MODBUS protocol.

8. 8.7. USER PARAMETERS menu

This menu contains the different functions for users such as language, password, buzzer, display, preferences, touchscreen calibration.

8. 8.8. SERVICE menu







This menu is reserved for support service personnel and holds STS identification data and utilities for software upgrades.

8. 9. ADDITIONAL USER FUNCTIONS

8. 9.1. Phase color modification

- Enter MAIN MENU > USER PARAMETERS > PREFERENCES

For each phase is possible to select a specific colour in a set of colour range. Those colours are applying in the measurements pages.

Colour	Default colour
 Yellow	Phase 3
 Orange	
 Red	
 Green	
 Light blue	Phase 2
 Dark blue	
 Purple	Phase 1
 Brown	
 Light grey	
 Dark grey	
 Black	

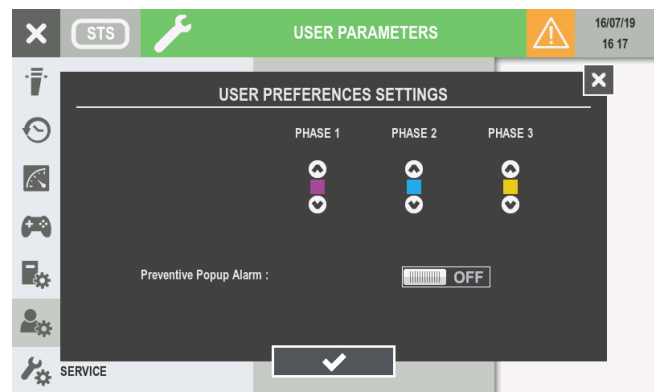

The popup alarm appears in case of critical alarms. This function can be extended to preventive alarms by switching “Preventive Popup Alarm” to ON.

8. 10. STS SETTINGS

please see § 7.6.4 Programming mode

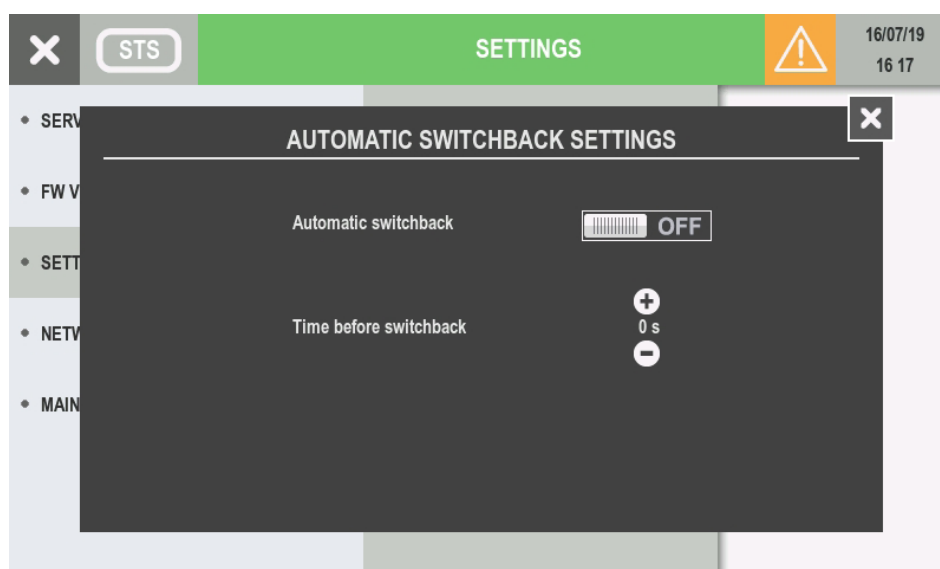
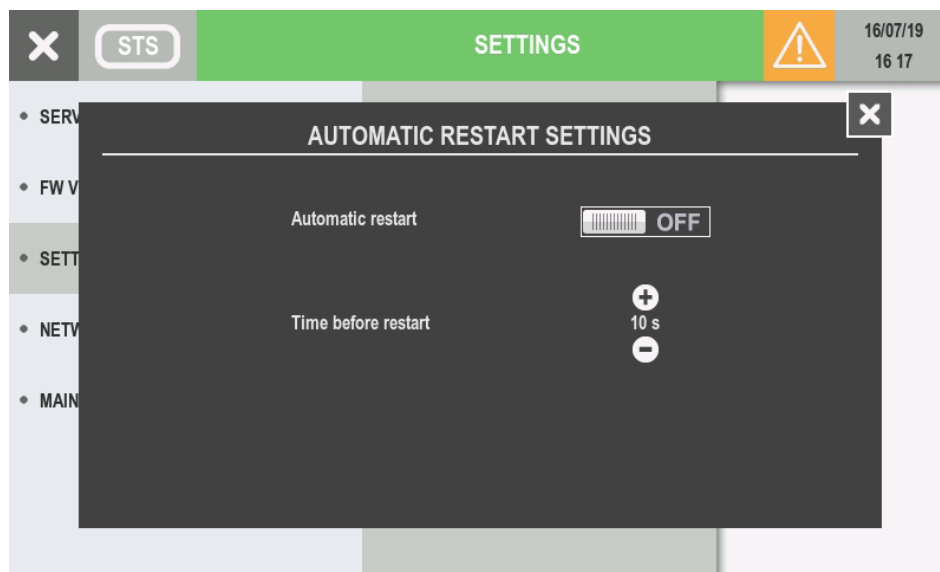
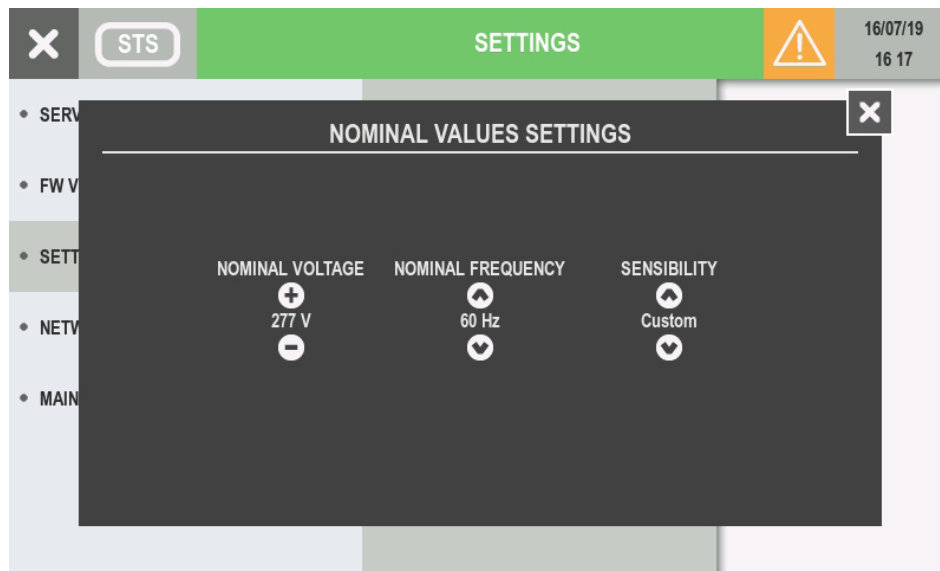

9. COMMISSIONING

9. 1. START CONDITIONS

- Source 1 and Source 2 voltages are present.

In the case of a standard cabinet installation:

- switches Q41, Q42, Q30 are open,
- inverter Q50 is set to position "0" (or Q51 and Q52 on 0 for STATYS 800/1000A).

9. 2. POWER-UP OF STATYS

- Close switches Q41 and Q42.

At this stage, the mimic panel lights up and the control electronics are powered ON. According to the automatic restart configuration (see § 7.6.4 or 8.10) conduction can then be activated on the output.

9. 3. SELECTING THE PREFERRED SOURCE

Note: According to the factory default setting, the preferred source is source 1.

Under normal operation, the load is supplied by the preferred source.

REMINDER: automatic transfer switches the supply from the preferred source to the alternate source. It is therefore important that the user defines the preferred source.

The preferred source is selected in "programming" mode (see § 7.6.4 or 8.10).

9. 4. LOAD SUPPLY

If conduction is not activated, the user may force the conduction (see § 7.6.2 or 8.8.5 Controls mode).

When STATYS is in conduction state, close switch Q30. According the display, unit shows  icon lights up (type Mimic panel, see § 7.2) or the colour of the bar on the diagram animation (type Touchscreen, see § 8).

9. 5. TRANSFER ONTO “MAINTENANCE BYPASS”

STATYS is equipped with two bypasses (except the “Integrable” model) which enable it to directly supply the load from source 1 or 2 without interrupting your application’s power supply.

This function is entirely secure, the switches are equipped with mechanical and electronic locks to minimise the risk of human error.

Since each source has its own “maintenance bypass”, two cases may be considered:

a. The load is supplied by source 1:

- set inverter Q50 to position I (or Q51 on 1 for STATYS 800/1000A),
- open switches Q30, Q41 and Q42.

At this stage, the SCR and the electronics are powered OFF.



b. The load is supplied by source 2:

- Set inverter Q50 to position II (or Q52 on 1 for STATYS 800/1000A),
- open switches Q30, Q41 and Q42.

At this stage, the SCR and the electronics are powered OFF.

9. 6. “MAINTENANCE BYPASS” RETURN

Since each source has its own “maintenance bypass”, two cases may be considered:

- a. Inverter Q50 is set to position I (or Q51 on 1 for STATYS 800/1000A):
 - Close Q41,
 - switch conduction onto source 1
 - visually check, according the display, that the green LED of static switch 1  is lit (type Mimic panel, see 7.2), or the colour of the bar on the diagram animation (type Touchscreen, see § 8),
 - once the LED is lit, close Q30,
 - set Q50 to position “0” (or Q51 on 0 for STATYS 800/1000A),
 - also close Q42 to enable a further changeover.
- b. Inverter Q50 is set to position II (or Q52 on 1 for STATYS 800/1000A):
 - Close Q42,
 - switch conduction onto source 2,
 - visually check, according the display, that the green LED of static switch 2  is lit (type Mimic panel, see 7.2), or the colour of the bar on the diagram animation (type Touchscreen, see § 8),
 - once the LED is lit, close Q30,
 - set Q50 to position “0” (or Q52 on 0 for STATYS 800/1000A),
 - also close Q41 to enable a further changeover.

10. COMMUNICATION INTERFACE

STATYS is equipped as standard with:

- one Ethernet port which allows the use of the SNMP protocol, the sending of E-mails following alarm activation and integrated Web page browsing
- one terminal block giving access to:
 - 1 dry contact relay for the general alarm
 - 1 dry contact relay for the preventive maintenance alarm
 - 1 inputs for an emergency stop button (button not supplied)
 - 2 outputs for accidental tripping of upstream protection (source 1 and source 2) (see § 8.6.1 on the installation manual)

STATYS is also equipped with 4 spare slots which can each house one communication module:

- 1 serial port (JBus/ModBus or Profibus or DeviceNet) on slot 1 only,
- 1 to 4 alarm relay modules (each module providing 3 inputs and 4 outputs).

11. ADVANCED DIAGNOSTICS AND PARAMETERS

STATYS is equipped with a diagnostic card for connection to a maintenance computer. This link can be used for adjusting the advanced parameters and other settings according to specific operational needs. Maintenance personnel can also use this link to download the event log, statistics and comprehensive information for rapid and complete diagnostics

Socomec: our innovations supporting your energy performance

1 independent manufacturer

3,900 employees
worldwide

8 % of sales revenue
dedicated to R&D

400 experts
dedicated to service provision

Your power management expert



POWER
SWITCHING



POWER
MONITORING



POWER
CONVERSION



ENERGY
STORAGE



EXPERT
SERVICES

The specialist for critical applications

- Control, command of LV facilities
- Safety of persons and assets
- Measurement of electrical parameters
- Energy management
- Energy quality
- Energy availability
- Energy storage
- Prevention and repairs
- Measurement and analysis
- Optimisation
- Consultancy, commissioning and training

A worldwide presence

12 production sites

- France (x3)
- Italy (x2)
- Tunisia
- India
- China (x2)
- USA (x2)
- Canada

30 subsidiaries and commercial locations

- Algeria • Australia • Austria • Belgium • China
- Canada • Dubai (United Arab Emirates) • France (x2)
- Germany • India • Indonesia • Italy • Ivory Coast
- Netherlands • Poland • Portugal • Romania • Serbia
- Singapore • Slovenia • South Africa • Spain • Sweden
- Switzerland • Thailand • Tunisia • Turkey • UK • USA

80 countries

where our brand is distributed



Socomec U.K. Limited, Unit 7-9 Lakeside Business Park, Broadway Lane, South Cerney, Cirencester, Glos. GL7 5XL.
www.socomec.co.uk

CORPORATE HQ CONTACT: SOCOMECSAS, 1-4 RUE DE WESTHOUSE, 67235 BENFELD, France.

HEAD OFFICE

SOCOMECS GROUP

SAS SOCOMECS capital 10 582 640 €
R.C.S. Strasbourg B 548 500 149
B.P. 60010 - 1, rue de Westhouse
F-67235 Benfeld Cedex
Tel. +33 3 88 57 41 41 - Fax +33 3 88 57 78 78
info.scp.isd@socomec.com

YOUR DISTRIBUTOR / PARTNER

www.socomec.com



100 years
OF SHARED ENERGY

socomec
Innovative Power Solutions