

MODULYS XM

50 to 250 + 50 kW

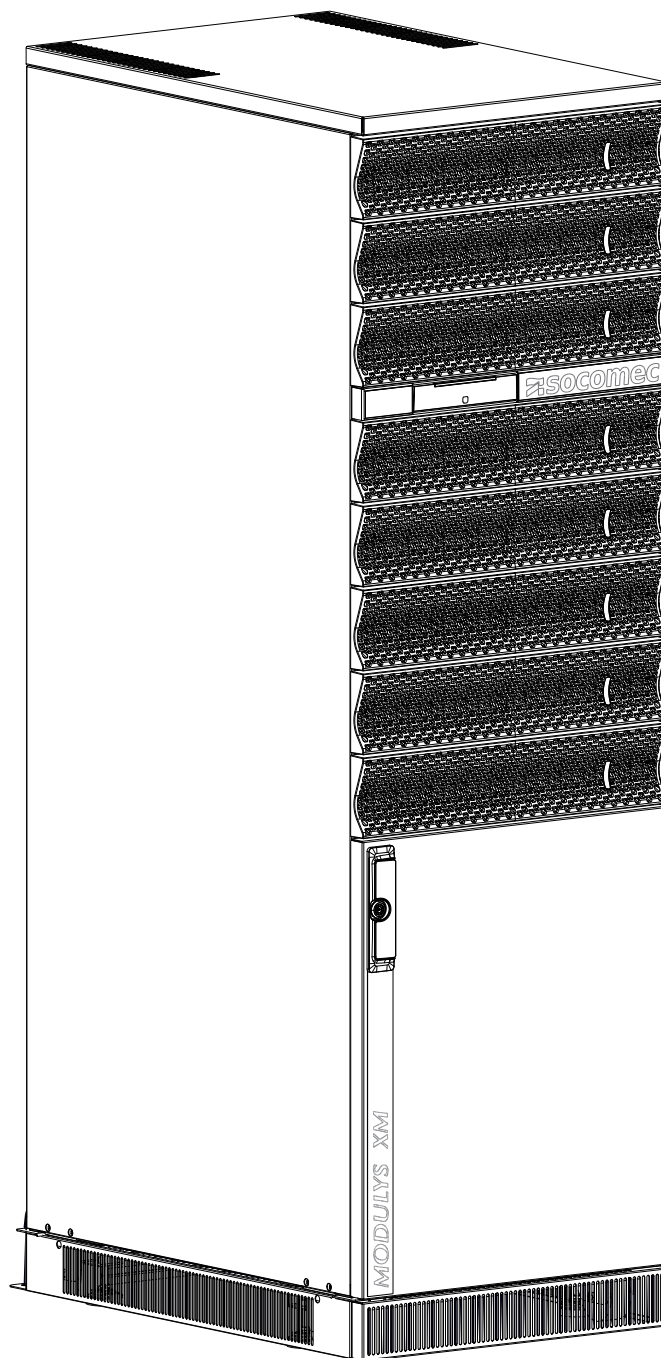

Socomec Resources Center
To download, brochures, catalogues
and technical manuals

CONTENTS

1. CERTIFICATE AND CONDITIONS OF WARRANTY	4
2. SAFETY STANDARDS	5
2.1. Description of symbols	6
2.2. Abbreviations	7
3. ENVIRONMENTAL REQUIREMENTS AND HANDLING	8
3.1. Environmental requirements	8
3.2. Handling	9
4. ELECTRICAL INSTALLATION	10
4.1. Cable positioning	13
5. OVERVIEW	14
6. CONNECTIONS	19
6.1. Mains and auxiliary mains connected separately	20
6.2. Mains and auxiliary mains connected together	20
6.3. External battery connection	21
6.4. Other connections	22
7. CONTROL PANEL	26
8. DISPLAY OPERATION	29
8.1. Display description	29
8.2. Menu architecture	30
8.3. Functioning mode	33
8.4. Status	33
8.4.1. Status page	33
8.5. Alarms management	34
8.5.1. Alarm report	34
8.5.2. Alarm popup	34
8.5.3. Alarm page	34
8.6. Synoptic animation	35
8.6.1. Additional icons	38
8.7. Event log page	38
8.8. Menu function descriptions	39
8.8.1. Entering passwords	39
8.8.2. MONITORING menu	39
8.8.3. EVENTS LOG menu	39
8.8.4. MEASUREMENTS menu	39
8.8.5. CONTROLS menu	39
8.8.6. UPS CONFIGURATION menu	40
8.8.7. USER PARAMETERS menu	40
8.8.8. SERVICE menu	40
8.9. Additional user functions	41
8.9.1. Phase colour modification	41

9. OPERATING PROCEDURES	42
9.1. Switching on.....	42
9.2. Switching off.....	42
9.3. Bypass operations.....	42
9.4. Extended out of service.....	43
9.5. Emergency shutdown.....	43
10. OPERATING MODES	44
10.1. On line mode.....	44
10.2. High efficiency mode.....	44
10.3. Converter mode.....	45
10.4. Operation with maintenance bypass.....	45
10.5. Operation with motor generator (GENSET).....	45
11. STANDARD FEATURES AND OPTION	46
11.1. ADC+SL card.....	47
11.1.1. Temperature sensor.....	49
11.2. LIB-ADC card.....	50
11.3. Net Vision card.....	50
11.3.1. EMD.....	51
11.4. ACS card.....	51
11.5. Modbus TCP card.....	51
11.6. BACnet card.....	51
11.7. Remote touchscreen display.....	51
11.8. PROFIBUS protocol interface.....	52
11.9. Top air exhausted.....	52
11.10. Kit for IP21.....	52
11.11. Top entry cables.....	53
11.12. Kit for common mains.....	53
11.13. Cold Start.....	53
12. TROUBLESHOOTING	54
12.1. System alarms.....	54
12.2. System status.....	55
13. PREVENTIVE MAINTENANCE	56
13.1. Batteries.....	56
13.2. Fans & capacitors.....	56
14. SAFEGUARDING THE ENVIRONMENT	57
15. TECHNICAL SPECIFICATIONS	58

1. CERTIFICATE AND CONDITIONS OF WARRANTY

This SOCOMEC continuous power system is guaranteed against any manufacturing or material defects.

The warranty is valid for 12 (twelve) months from the commission date, provided activation is carried out by SOCOMEC personnel or personnel from a support centre authorised by SOCOMEC, and no more than 15 (fifteen) months from being shipped from SOCOMEC.

The warranty is valid throughout national territory. If the UPS is exported abroad, the warranty will only cover the parts used to repair faults.

The warranty is valid ex-works and covers labour and parts used to repair the faults.

The warranty shall not apply in the following cases:

- Failure due to unforeseen circumstances or force majeure (lightning, floods, etc.);
- Failure due to negligence or improper use (use outside limits: temperature, humidity, ventilation, electric power supply, applied load, batteries);
- Insufficient or inappropriate maintenance;
- When maintenance, repairs or modifications have not been carried out by SOCOMEC personnel, or personnel from a support centre authorised by SOCOMEC.
- If the battery has not been recharged in accordance with the terms indicated on the packaging and in the manual, in the event of long periods of storage or UPS inactivity.

SOCOMEC may, at its own discretion, opt for the repair of the product or the replacement of faulty or defective parts with new parts, or with used parts of equivalent quality to new parts with regard to function and performance.

Defective or faulty parts replaced free of charge must be made available to SOCOMEC, which becomes the sole owner.

Replacement or repair of parts, or any modifications to the product during the warranty period, will not extend the duration of the warranty.















SOCOMEC will not be responsible for damages under any circumstances (including, without limitations, damage for loss of earnings, interruption of activity, loss of information or other financial losses) arising from the use of the product.

SOCOMEC retains the full and exclusive ownership rights to this document. Only a personal entitlement to use the document for the application indicated by SOCOMEC is granted to the recipient of this document. The reproduction, modification, distribution of this document, either partially or wholly and in any manner, is strictly prohibited except upon Socomec's express prior written consent.



This document is not a specification. SOCOMEC reserves the right to make any changes to the information provided without prior notice.

2. SAFETY STANDARDS

This user manual specifies installation and maintenance procedures, technical data and safety instructions for SOCOMEC. For further information visit the Socomec website: www.socomec.com.

	NOTE! Any work carried out on the equipment must be performed by skilled, qualified technicians.
	NOTE! Before carrying out any operations on the unit read the installation and operating manual carefully. Keep this manual safe for future reference.
	DANGER! Failure to observe safety standards could result in fatal accidents or serious injury, and damage equipment or the environment.
	CAUTION! If the unit is found to be damaged externally or internally, or any of the accessories are damaged or missing, contact SOCOMEC. Do not operate the unit if it has suffered a violent mechanical shock of any kind.
	NOTE! Install the unit in accordance with clearances in order to allow access to handling devices and guarantee sufficient ventilation (refer to 'Electrical requirements' chapter).
	NOTE! Only use accessories recommended or sold by the manufacturer.
	NOTE! When the equipment is transferred from a cold to a warm place wait approx. two hours before putting the unit into operation.
	NOTE! When carrying out electrical installation, all standards applicable specified by the IEC, in particular IEC 60364, and the electricity supplier must be observed. All national standards applicable to batteries must be observed. For further information refer to 'Technical specifications' chapter.
	WARNING! Connect the protective earth (PE) conductor before making any other connections.
	NOTE! The installer is responsible for implementing the backfeed protection with the use of AC input line isolation devices external to the UPS. Refer to 'Electrical requirements' chapter.
	DANGER! RISK OF ELECTRIC SHOCK! Before carrying out any operations on the unit (cleaning and maintenance performances, connection of appliances, etc.) disconnect all power sources.
	DANGER! RISK OF ELECTRIC SHOCK! After disconnecting all power sources wait approx. 5 minutes for the complete discharge of the unit.
	NOTE! The UPS may be powered from an IT distribution system with a neutral conductor.
	NOTE! Any use other than the specified purpose will be considered improper. The manufacturer/supplier shall not be held responsible for damage resulting from this. Risk and responsibility lies with the system manager.











NOTE! The product you have chosen is designed for commercial and industrial use only. Products may have to be adapted if used for particular critical applications such as life support systems, medical applications, commercial transportation, nuclear facilities or any other application or system where product failure is likely to cause substantial harm to people or property. For such uses we would advise you to contact SOCOMEC beforehand to confirm the ability of these products to meet the required level of safety, performance, reliability and compliance with applicable laws, regulations and specifications.







	NOTE! This is a product for commercial and industrial application – installation restrictions or additional measures may be needed to prevent disturbances.
	WARNING! This is a category C3 UPS product. In a residential environment, this product may cause radio interference, in which case the user may be required to take additional measures.

Safety requirements for secondary batteries and battery installations.

	The installer is responsible for ensuring that the battery installation and their operating environment conform to national and international codes and safety standards.
--	--

2.1. Description of symbols

Symbols	Description
	Protective earth terminal (PE).
	Authorised personnel only. Only qualified personnel are permitted to work on the batteries.
	Do not use naked flames or cause sparks in the vicinity of the accumulators.
	No smoking.
	Batteries charging! Batteries and related parts contain lead which is dangerous to health if ingested. Wash hands after handling!
	Accumulators are heavy! Use suitable transport and lifting equipment to work safely.
	Risk of electric shock! Connecting accumulators in series creates hazardous voltages.
	Risk of explosion! Avoid short circuits! Never place tools or metal objects on the accumulators.
	Corrosive liquids (electrolyte).
	Read the user instructions carefully. Read the user manual before performing any operations.
	Wear protective gloves

Symbols	Description
	Wear safety shoes.
	Wear protective goggles.
	In the event of accidents, improper use, failure or electrolyte leakage wear a protective apron.
	In the event of accidents, improper use, failure or electrolyte leakage wear a gas mask.
	In the event of contact with the eyes, wash immediately with plenty of water and call a doctor. Call a doctor immediately in the event of accidents or illness.
	Do not dispose of in normal waste stream (symbol WEEE).

2.2. Abbreviations

For the purpose of this document, the following abbreviations are used:

BMS	Battery Management System
EMC	Electro Magnetic Compatibility
IEC	International Electrotechnical Commission
LIB	Li-Ion battery
PE	Protective Earth
THDI	Total Harmonic Distortion in Current
THDV	Total Harmonic Distortion in Voltage
UPS	Uninterruptible Power Supply

3. ENVIRONMENTAL REQUIREMENTS AND HANDLING



NOTE!

Before carrying out any operations on the unit read the 'Safety standards' chapter carefully.

3.1. Environmental requirements

The room must be:

- of a suitable size;
- free from conductive, inflammable and corrosive items;
- not exposed directly to sunlight.

The floor must support the weight of the unit and guarantee its stability. The unit is designed for indoor installation only.

Room positioning

Top view: rear air outlet

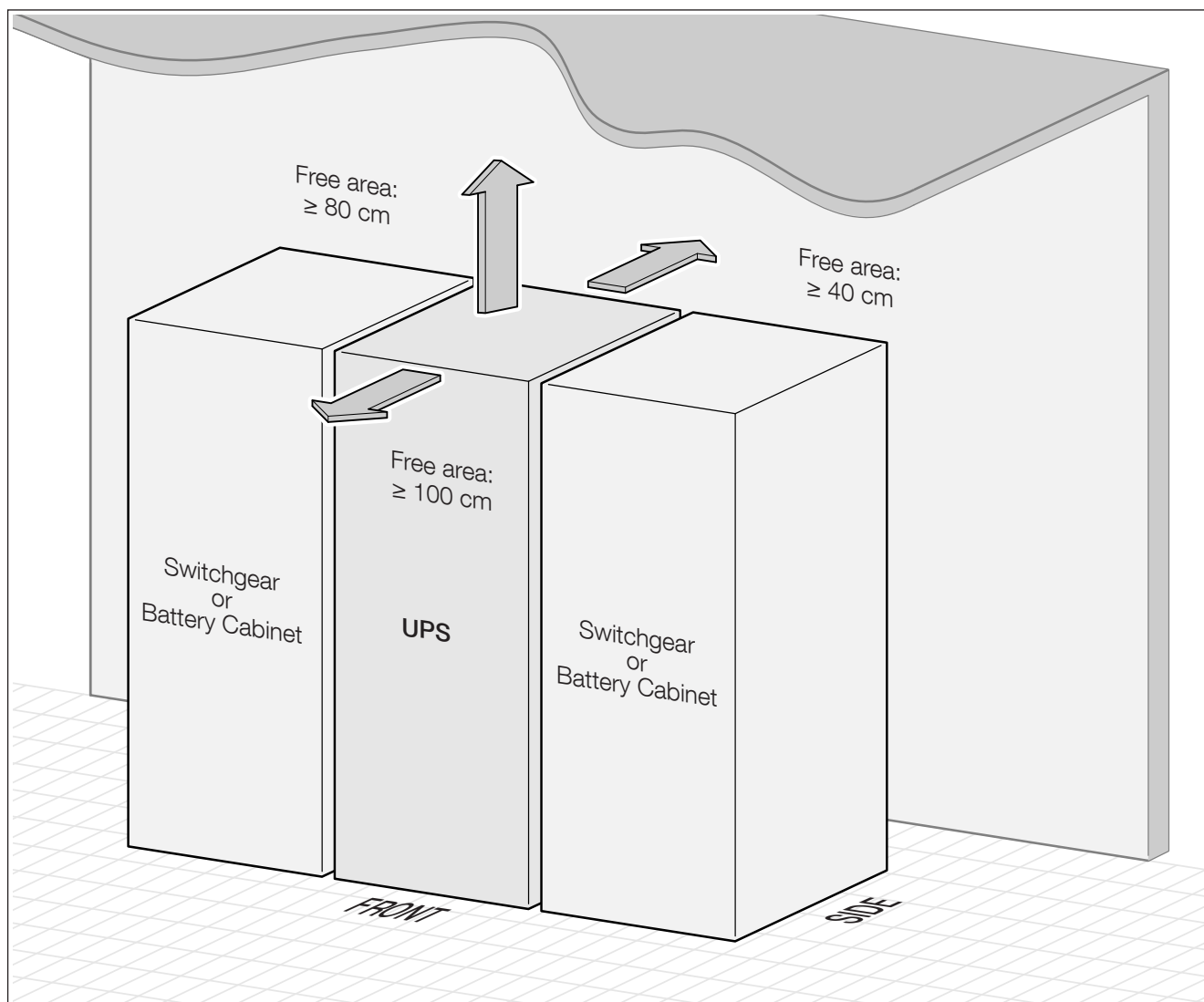

(1) Suggested Clearances in the worst case condition (@ Nominal Load and 40 C° ambient temperature). Contact SOCOMEC for different installation and application conditions.

In-row configuration

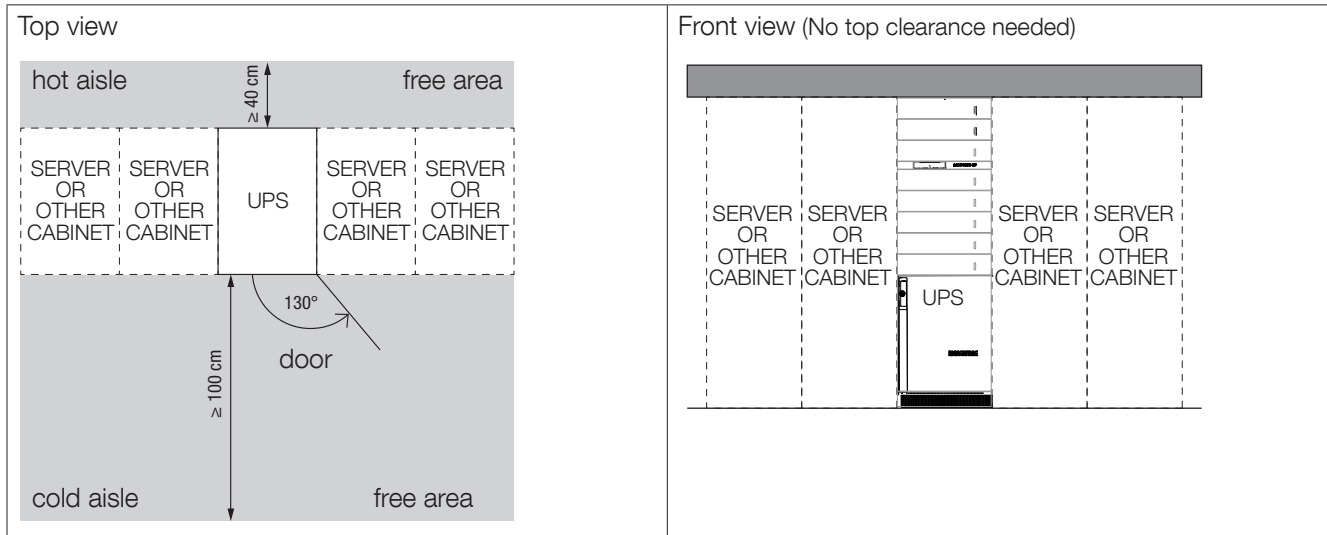

3.2. Handling

- The packaging guarantees the stability of the unit during shipping and physical transfer.
- The unit must remain in a vertical position during all shipping and handling operations.
- Ensure that the floor is strong enough to support the weight of the unit.
- Carry the packaged unit as close as possible to the installation site.

	WARNING! HEAVY WEIGHT! Move the unit using a fork lift truck taking the utmost caution at all times.
	The unit MUST be handled by at least two people. The people MUST take position at the sides of the UPS with respect to the direction of movement.
	Do not move the unit by putting pressure on the front door.
	When moving the unit on even slightly sloping surfaces, use the locking equipment and braking devices to ensure that the unit does not fall over.
	WARNING! The following instructions must be carried out prior to moving the unit (after initial positioning). Failure to heed this warning could result in the unit falling over, equipment damage, injury and even death.
	WARNING! RISK OF TIPPING OVER! The four feet must be secured evenly to ensure the unit is stable.

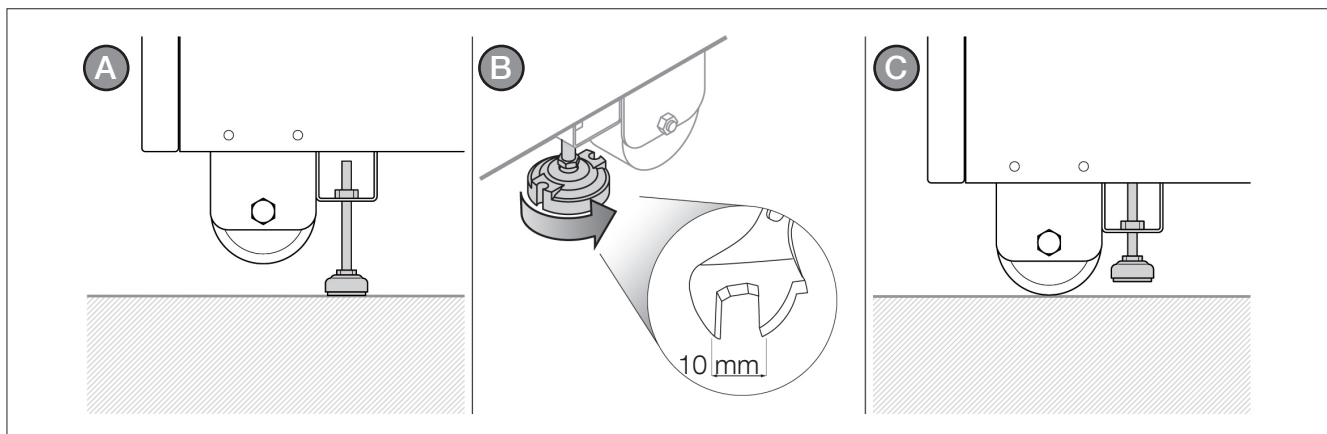

4. ELECTRICAL INSTALLATION



NOTE!
Before carrying out any operations on the unit read the 'Safety standards' chapter carefully.

UPS configuration

Mains and Auxiliary mains connected separately (with external batteries)

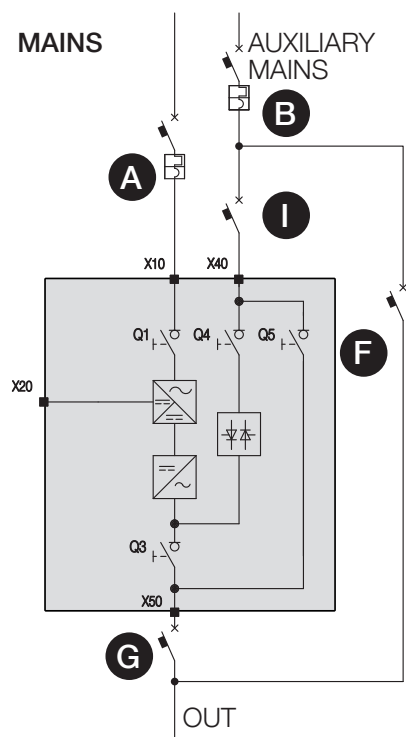

KEY

- A** Input mains thermal-magnetic circuit breaker.
- B** Auxiliary mains thermal-magnetic circuit breaker.
- F** External maintenance bypass switch⁽¹⁾.
- G** Unit output switch.
- I** Unit Auxiliary mains switch.
-  UPS

(1) Connect a normally-closed early make contact from the External Maintenance bypass switch to the dedicated connector.

Electrical requirements

The installation and system must comply with national plant regulations. The electrical distribution panel must have a sectioning and protection system installed for input and auxiliary mains. RCD is not necessary when the UPS is installed in a TN-S system. RCD is not allowed on TN-C systems. If a RCD is required a B-type should be used.

SYSTEM CABLE - MAX SELECTION		1	2	3	4	5	6
Rectifiers terminals (mm ²) ⁽¹⁾	Flexible	2 x 150 (M10)					
	Rigid	2 x 150 (M10)					
Bypass terminals (mm ²) ⁽¹⁾	Flexible	2 x 150 (M10)					
	Rigid	2 x 150 (M10)					
Battery terminals (mm ²)	Flexible	2 x 150 (M10)					
	Rigid	2 x 150 (M10)					
Output terminals (mm ²) ⁽¹⁾	Flexible	2 x 150 (M10)					
	Rigid	2 x 150 (M10)					

M10 terminals Tightening torque 20 Nm

Max. section is determined by the size of the terminals.

(1) Neutral conductor has to be sized not less than the phase conductor.

RECOMMENDED PROTECTION DEVICES - Rectifier								
Number of Modules		1	2	3	4	5	6	
N+1 redundant System Power (kW)		50 + 0 ⁽¹⁾	50 + 50	100 + 50	150 + 50	200 + 50	250 + 50	
C Curve circuit breaker (A)	min.	100	200	320	400	450	450	
	max.	450	450	450	450	450	450	
Differential input ⁽²⁾ (A)	min.	0,5						

Circuit breaker switch recommended with magnetic intervention threshold $\geq 10 I_n$ (curve C). It is necessary to use a D curve selective breaker if an optional external transformer is used. The min value depends on the size of the power cables in the installation, while the max value is limited by the UPS cabinet.

(1). No redundancy





(2). Caution! Residual Current Detection (RCD) can only be used with a common input and auxiliary mains (configuration not recommended). It must be placed upstream of the connection between input mains and auxiliary mains. Use type B fourpole selective (S) residual current detectors. Load leakage currents are to be added to those generated by the UPS and during transitory phases (power failures and power returns) short current peaks may occur. If loads with high leakage current are present, adjust the residual current protection. It is advisable in all cases to carry out a preliminary check on the earth current leakage with the UPS installed and operational with the definitive load, so as to prevent the RCD tipping over.

RECOMMENDED PROTECTION DEVICES - Auxiliary mains							
Number of Modules		1	2	3	4	5	6
N+1 redundant System Power (kW)		50 + 0 ⁽¹⁾	50 + 50	100 + 50	150 + 50	200 + 50	250 + 50
C Curve circuit breaker (A)	min.	100	200	320	400	400	400
	max.	450	450	450	450	450	450

Circuit breaker switch recommended with magnetic intervention threshold $\geq 10 I_n$ (curve C). It is necessary to use a D curve selective breaker if an optional external transformer is used. The min value depends on the size of the power cables in the installation, while the max value is limited by the UPS cabinet.

(1). No redundancy

The conditional short circuit current (I_{cc}) according to IEC 62040-1 is 65 KA rms, provided that the UPS is protected by a MCCB with adequate breaking capability and current limiting capability under short circuit conditions. Contact SOCOMEC for detailed information.

	<p>NOTE! To ensure the integrity of the bypass thyristors:</p> <ul style="list-style-type: none"> - I^2t must be lower than 500 kA²s and peak current must be lower than 10 kA for 20 ms in case of Standard System. - I^2t must be lower than 2000 kA²s and peak current must be lower than 20 kA for 20 ms in case of System with redundant bypass. <p>Contact SOCOMEC for detailed information.</p>
	<p>The UPS is designed for transient overvoltages in category II installations. If the UPS is part of the building's electrical circuit, or is likely to be subject to transient overvoltages in category III installations, additional external protection must be provided, either on the UPS or in the AC power supply network powering the UPS.</p>
	<p>WARNING! Protective earthing conductor (PE) must have sufficient current-carrying capacity. The PE cable core size must be chosen according to the PROTECTIVE CURRENT RATING of the earth circuit which depends on the provision and location of protective overcurrent devices.</p>
	<p>NOTE! 3-Phase 4-Wire Input Power is required. The unit can be installed in TN, TT and IT AC distribution systems (IEC 60364-3).</p>

Backfeed protection

The UPS is set up for the installation of external protection devices against the backfeed of dangerous voltages on the auxiliary backup mains power supply line (AUX MAINS SUPPLY). The current rating of the switching device has to follow the instruction outlined in 'Electrical requirements' chapter.



DANGER! RISK OF ELECTRIC SHOCK!
The installer must attach the warning label in order to warn electrical technicians about dangerous backfeed situations (not caused by the UPS).

Warning label (supplied with the equipment)

Before working on this circuit

- Isolate the Uninterruptible Power System (UPS)
- Then check for Hazardous Voltage between all terminals including the protective earth

 **Risk of Voltage Backfeed**

Backfeed electrical diagram

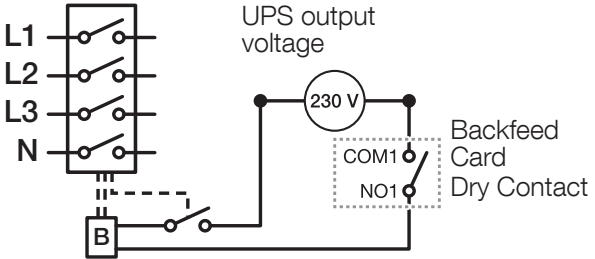

Backfeed card

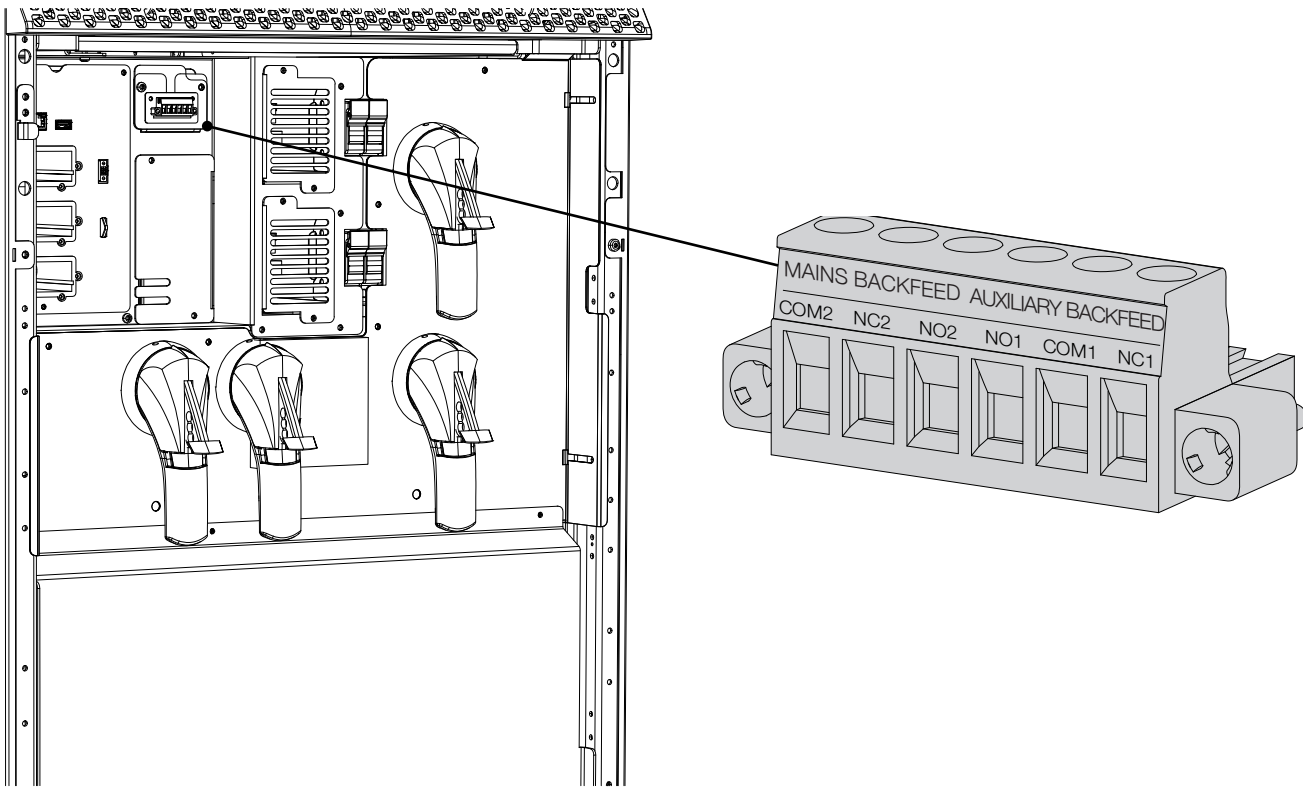







NOTE!
Use a 220-240 V release coil with integrated travel limit contact to pilot the input protection systems. If a trip coil without an integrated end-of-travel contact is used, an early auxiliary contact must be added (see figure). Electrical data of the contacts: 2 A 250 Vac.

Function	Detail <small>(Connector name)</small>	V OUT	Internal fuse
BKF AUX	COM1 _(XB1) - NO1 _(XB3)	230 V RMS	2 A time delay



The backfeed protection for the input mains supply (MAINS SUPPLY) is incorporated inside the UPS modules as standard.

4.1. Cable positioning

	WARNING! The cables must be installed on trays according to the following diagrams. The trays must be positioned near the UPS.
	WARNING! All metal and suspended ducts or those in raised flooring MUST be connected to earth and to the various cabinets
	WARNING! Power cables and control cables MUST NEVER be installed in the same duct.
	WARNING! Risk of electromagnetic interference between battery cables and output cables.

Correct installation

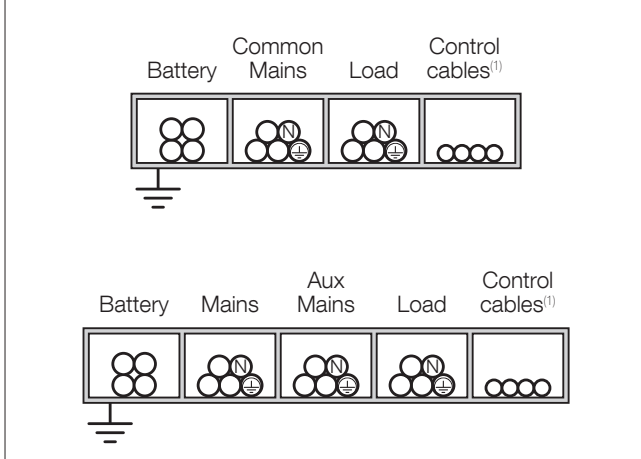

Acceptable installation

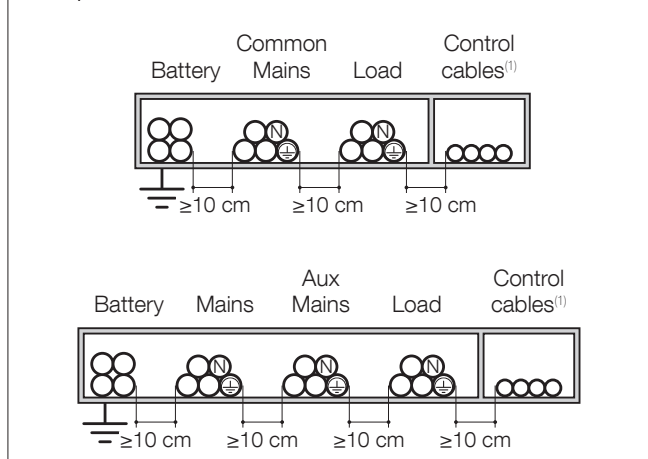

(1) Control cables: connections between the cabinets and each unit, alarm signals, remote mimic panel, connection to the BMS (Building Management System), emergency stop, connection to generator.

5. OVERVIEW

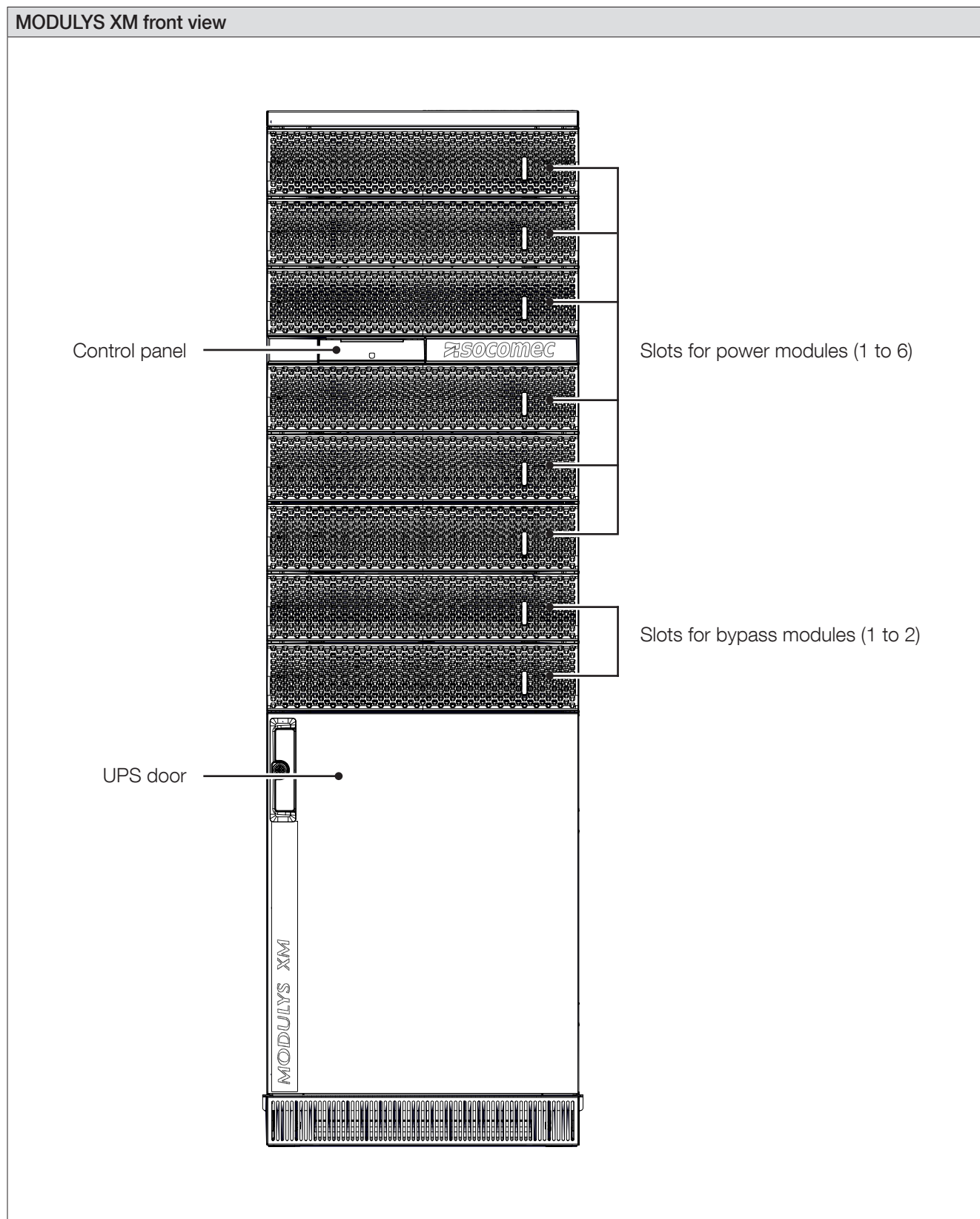

NOTE!
MODULYS XM is available in four different configurations:

- System with manual bypass, input, aux. mains and output switches (standard system);
- System with manual bypass, input, aux. mains, output switches and 1+1 redundant bypass module;
- System with manual bypass, input, aux. mains, output switches and internal backfeed;
- System with manual bypass, input, aux. mains, output switches, internal backfeed and 1+1 redundant bypass module.

System with manual bypass, input, aux. mains and output switches (with or without redundant bypass module)

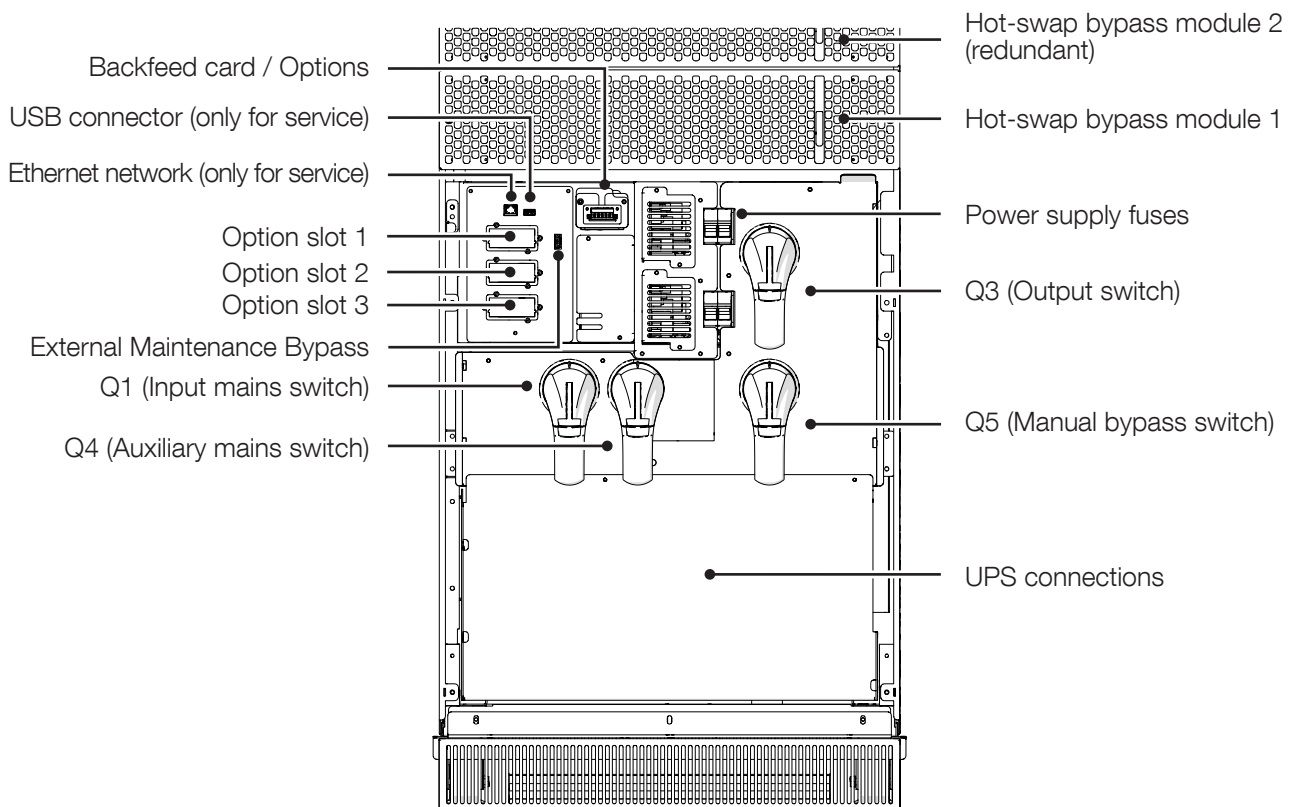

Standard System

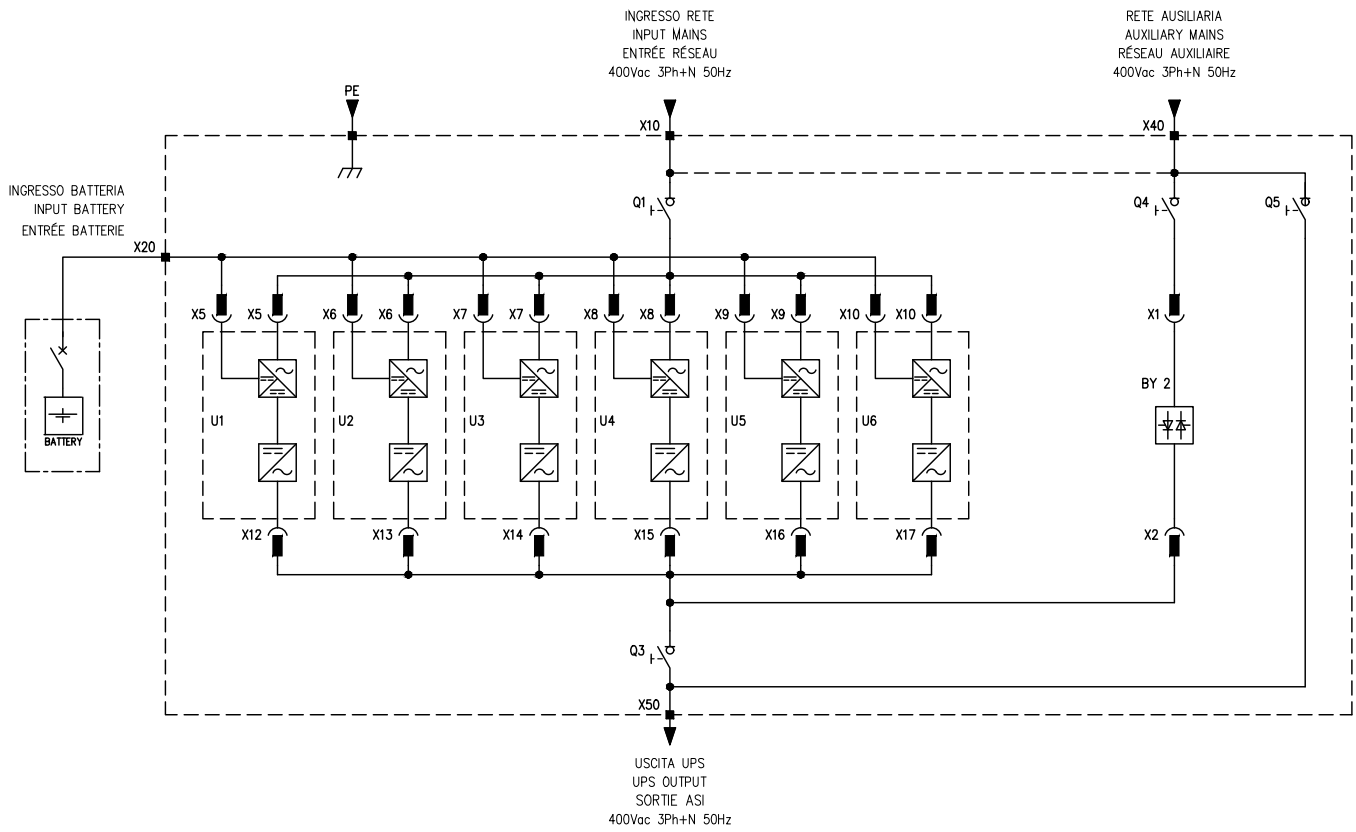

System with 1+1 redundant bypass module

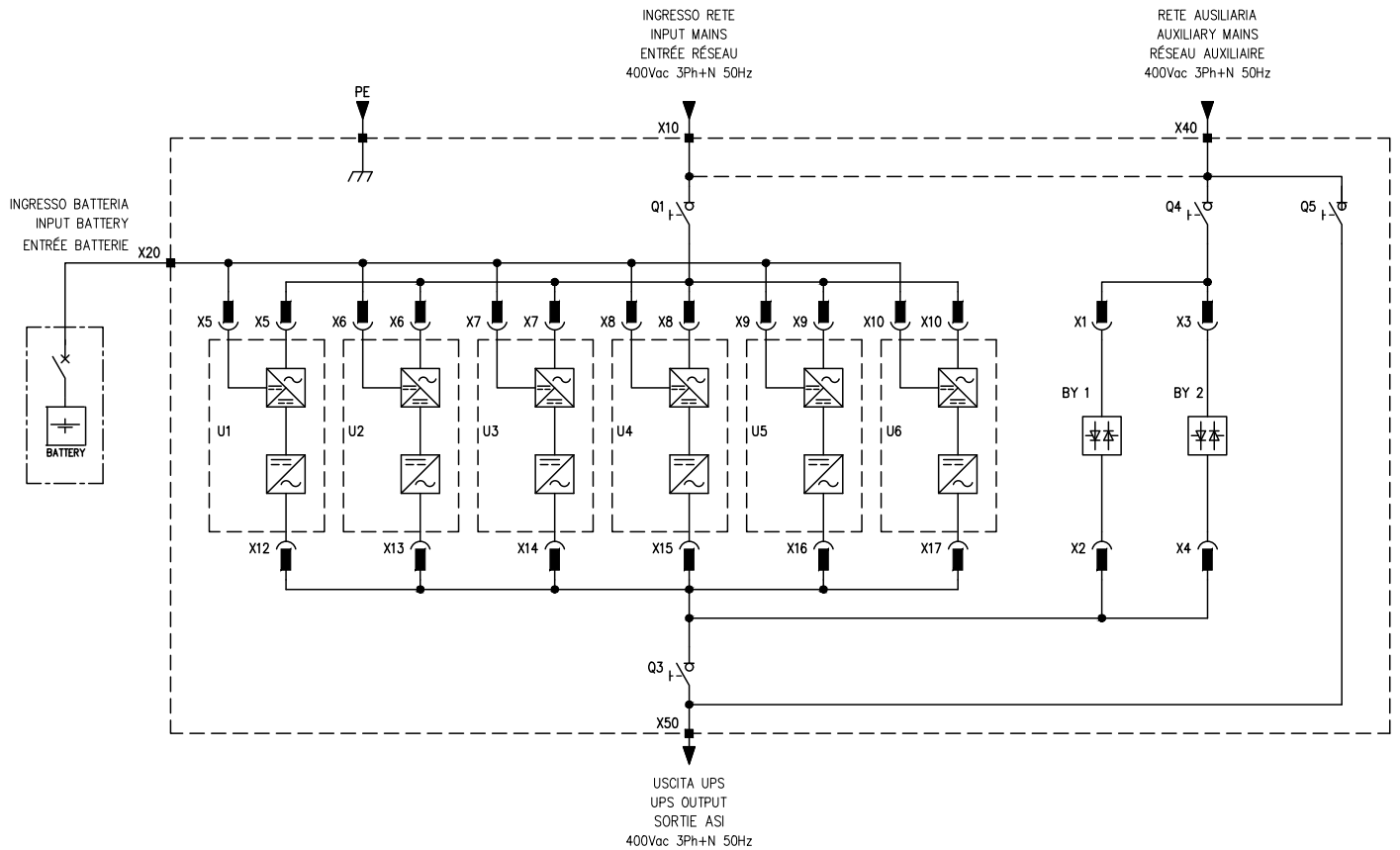

System with manual bypass, input, aux. mains and output switches and internal backfeed (with or without redundant bypass module).

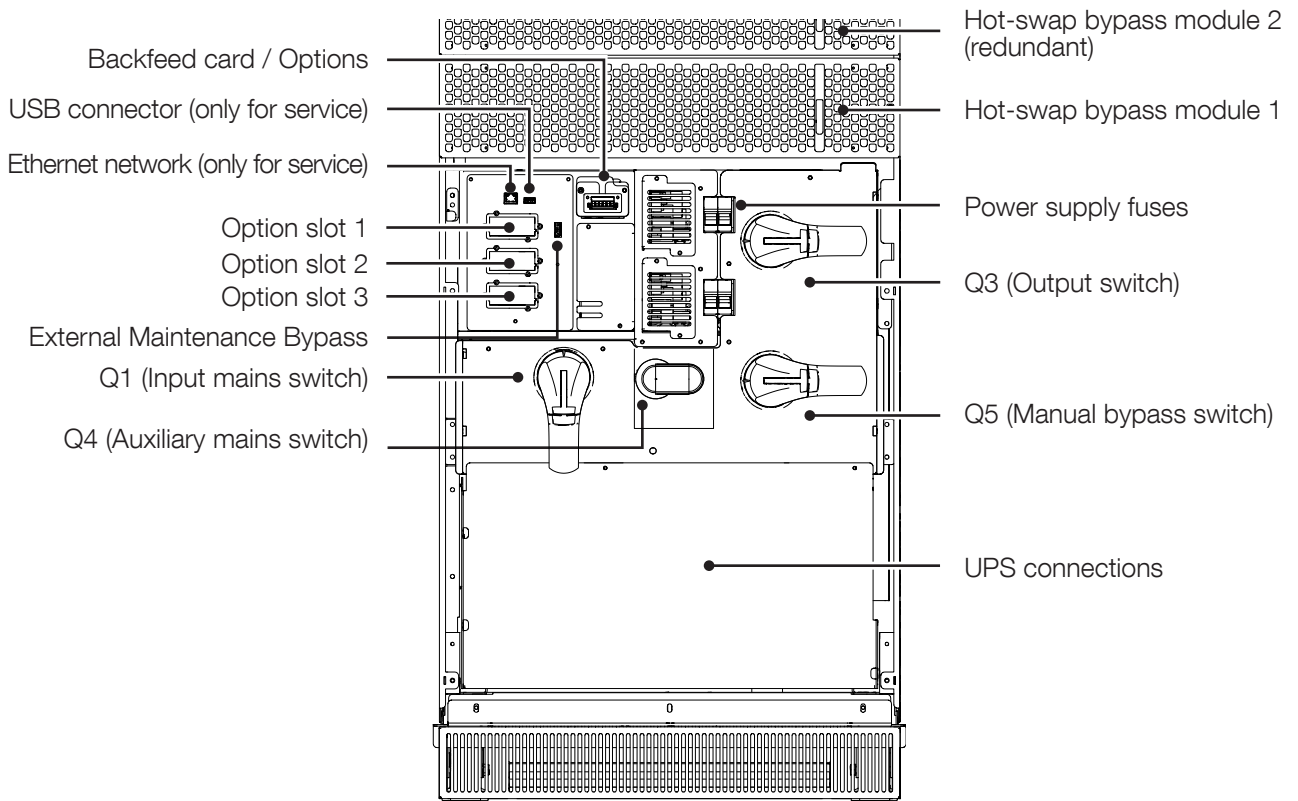

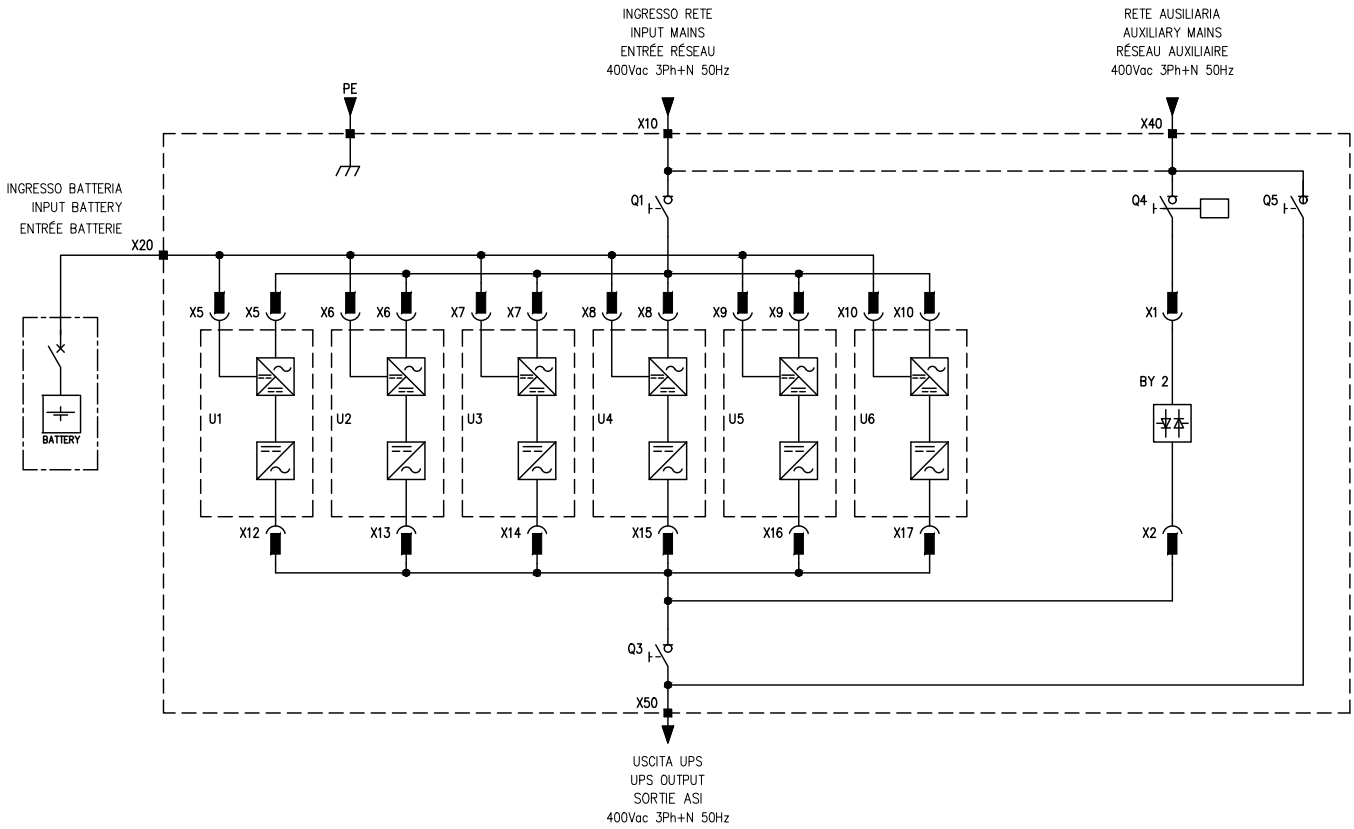

System with internal backfeed

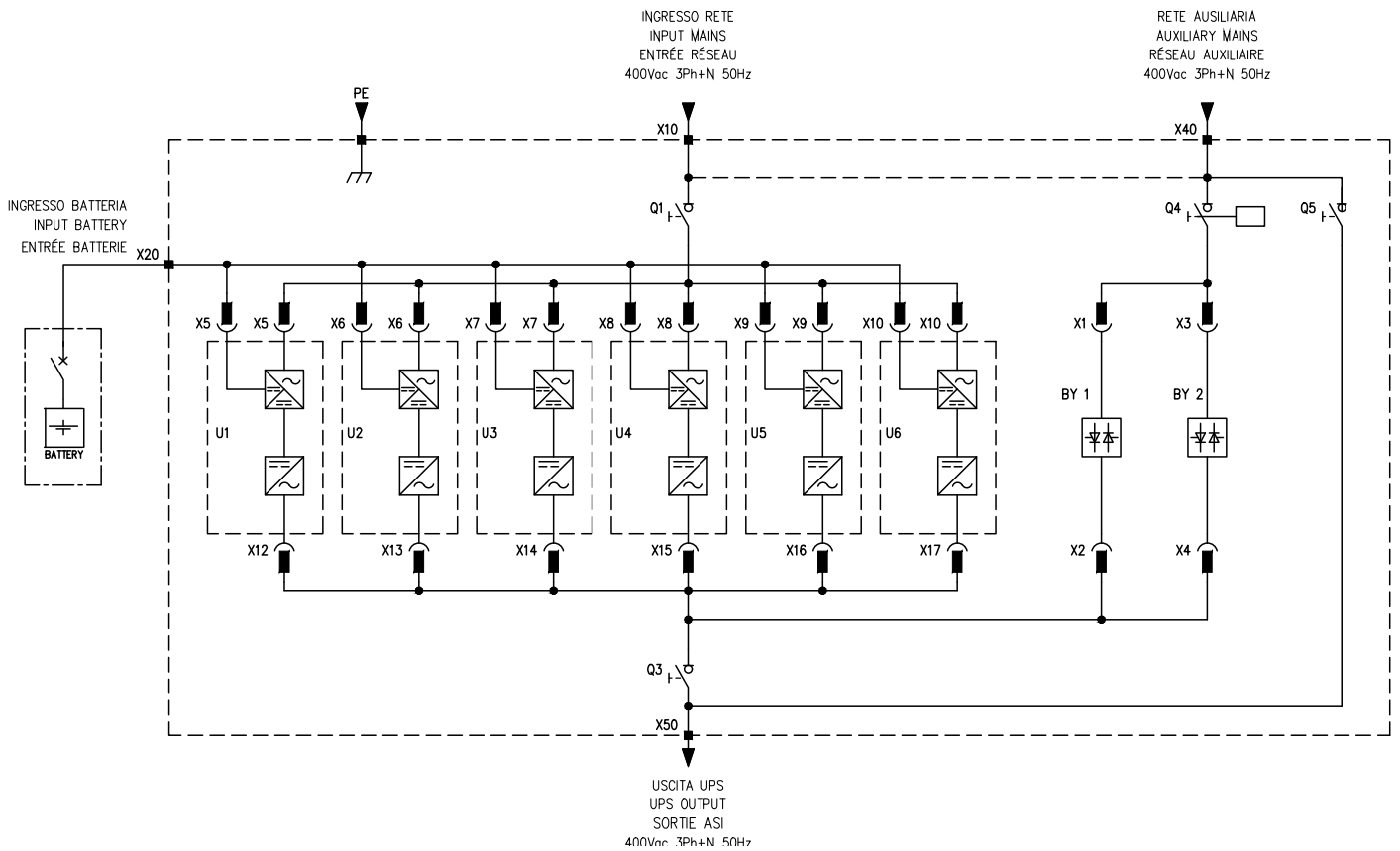

System with internal backfeed and 1+1 redundant bypass module



6. CONNECTIONS

	NOTE! Before carrying out any operations on the unit read the 'Safety standards' chapter carefully.
	WARNING! Battery power terminals can be supplied by: <ul style="list-style-type: none">• external battery cabinet;• UPS power modules. Before working on this circuit ensure that: <ul style="list-style-type: none">• all the external battery cabinet switches are in OFF position;• the UPS is in maintenance bypass mode (refer to 'Operating modes' chapter);• all UPS power modules are disconnected; Check the absence of voltage before carrying out any operation..

Floor mounting anti-intrusion installation kit

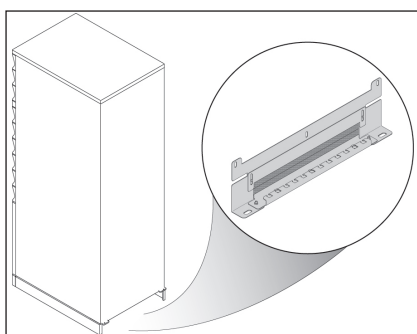

NOTE!
The cables coming from the rear of the unit must pass through the appropriate gap.
This operation must be carried out:

- before wiring operations;
- before securing the kit to the unit and the floor.

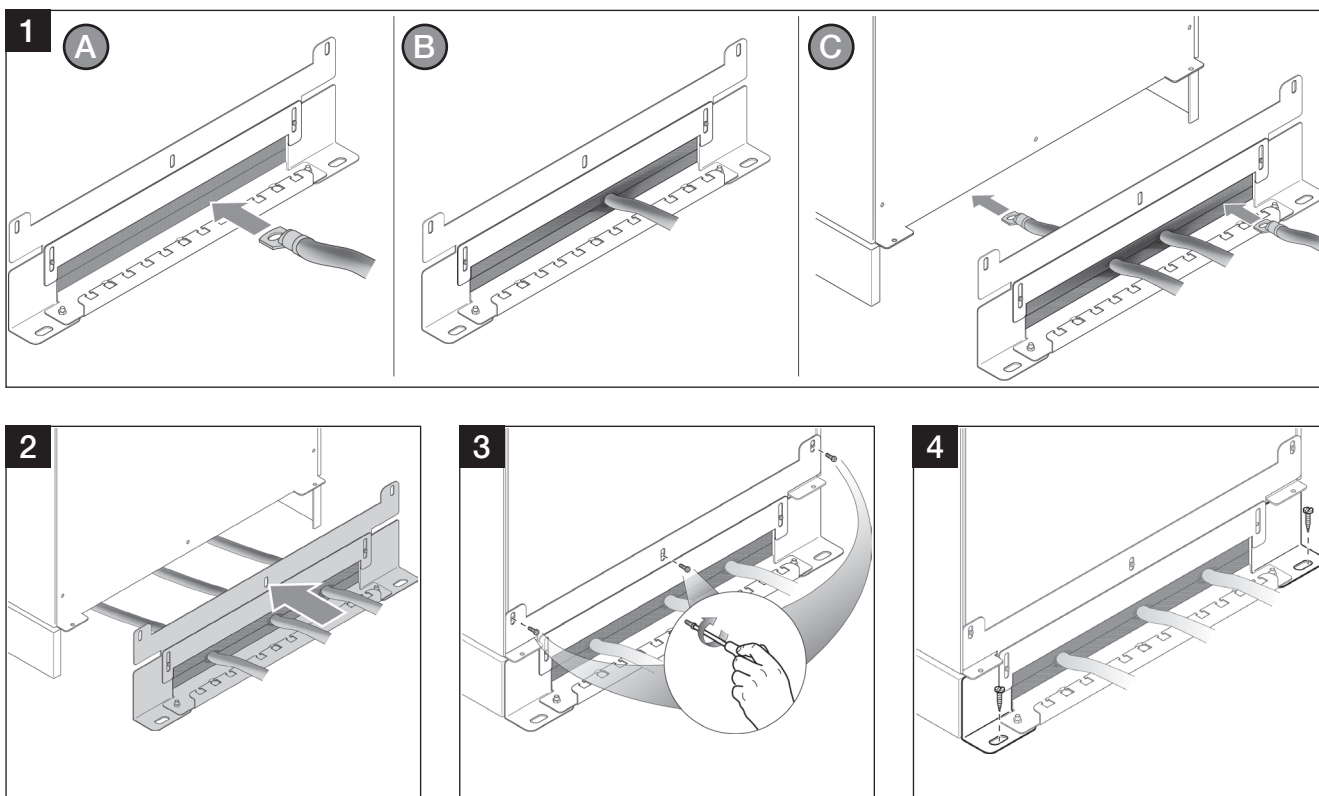

6.1. Mains and auxiliary mains connected separately

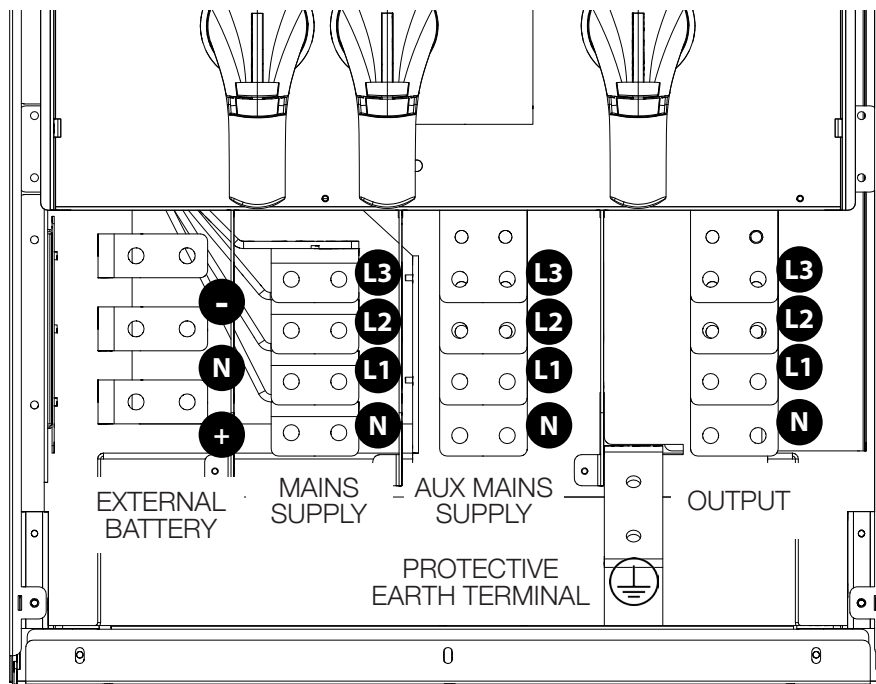

6.2. Mains and auxiliary mains connected together



This configuration is possible only with kit for common mains option. See 'Standard features and option' chapter.

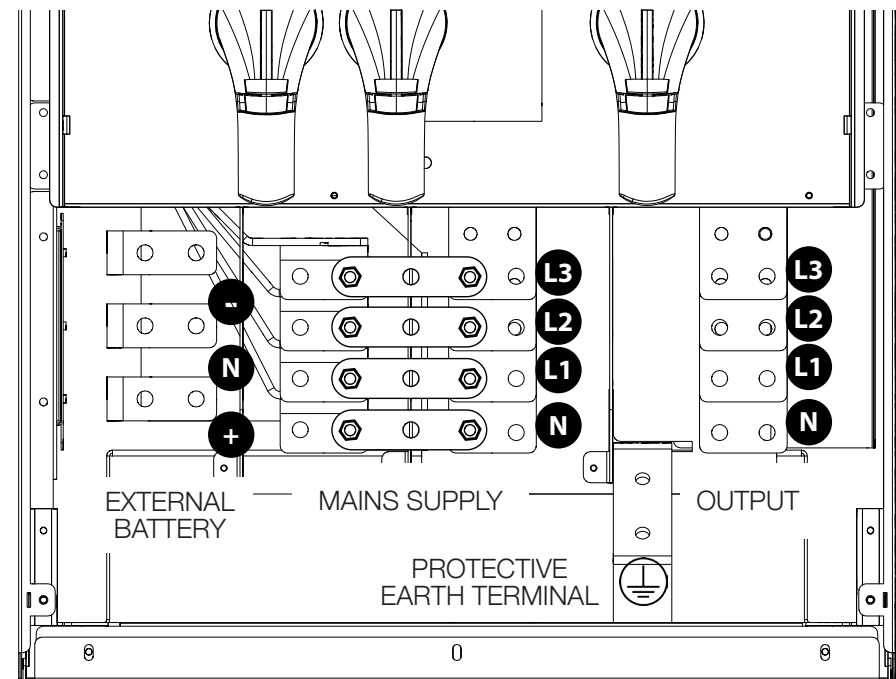

6.3. External battery connection



NOTE!
For further information refer to the battery cabinet manual.

- Remove the plastic terminal block protection.
- Connect the protective earth (PE) cable.
- Connect the cables between the UPS terminals and the battery cabinet terminals.



WARNING!
Strictly observe:

- the polarity of each individual string (refer to the figure below);
- the cable cross section (refer to 'Electrical requirements' chapter).



WARNING!
Cabling errors with inversion of battery polarity may cause permanent damage to the equipment.



Reassemble the plastic terminal block protection.

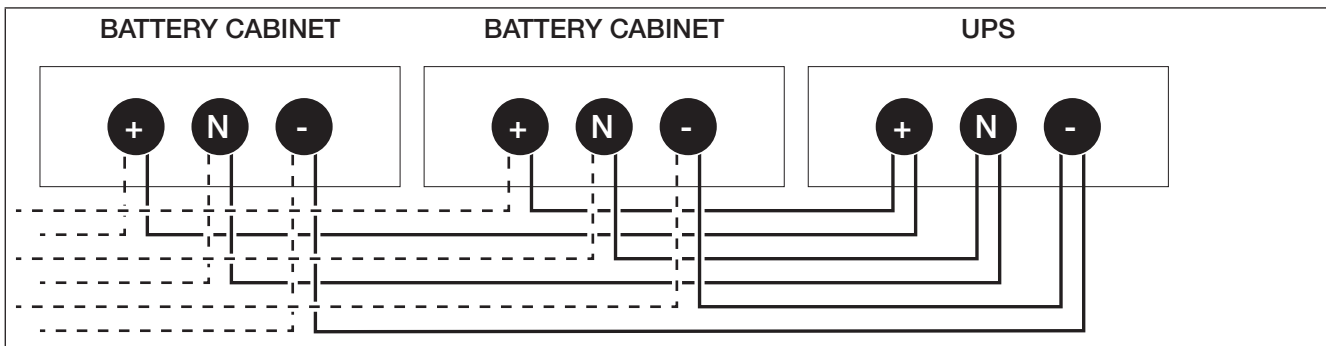

Note!
When battery cabinets not supplied by Socomec are used, the installer is responsible for:

- checking electrical compatibility;
- checking the presence of appropriate protective devices (fuses and switches that ensure the cables are protected from the UPS to the battery cabinet).

Once the UPS is switched on – before closing the battery switches – check the battery parameters on the control panel menu. For further information, refer to 'Display operation' chapter.





Note!
Not all battery/capacity combinations are available.



Note for Li-ion batteries (LIB):
The UPS interface to the Li-ion batteries (LIB), which could be based on a communication protocol or on dry contacts, monitors battery operation for the sole purpose of ensuring overall system service. This UPS battery interface cannot in any way replace safety systems to protect the battery against abuse or improper use, which requires an independent system in compliance with the relevant standards.

6.4. Other connections

	Note! Before carrying out any operations on the unit read the 'Safety standards' chapter carefully.
	WARNING! RISK OF TIPPING OVER! Before carrying out any operations, ensure the UPS is secured at the feet.
	WARNING! RISK OF TIPPING OVER! The four feet must be secured evenly to ensure the unit is stable.

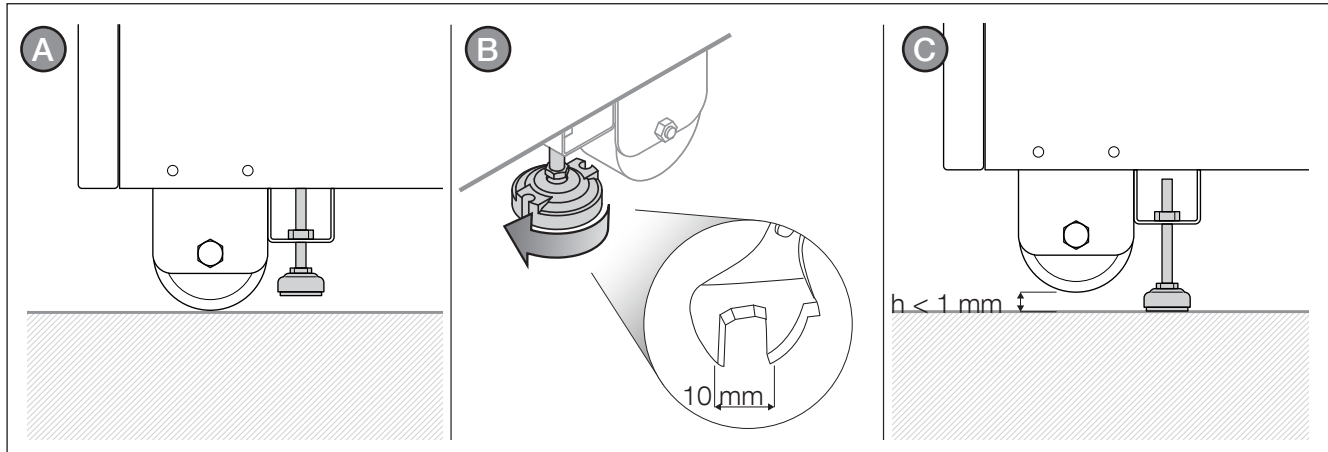

	WARNING! RISK OF TIPPING OVER! The modules must be inserted from the bottom upwards and removed from the top downwards to ensure the unit remains stable.
---	---

Power module insertion

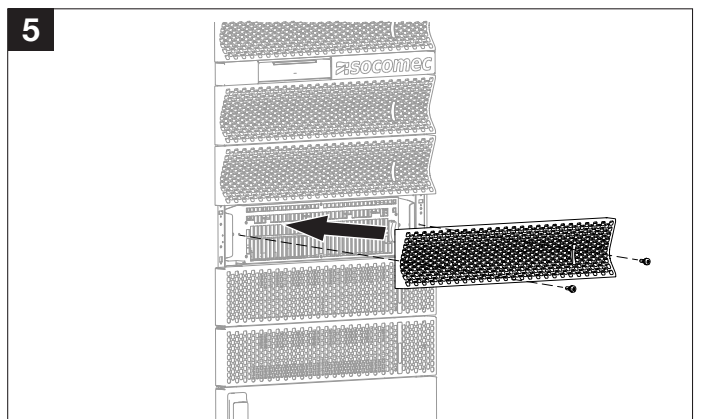
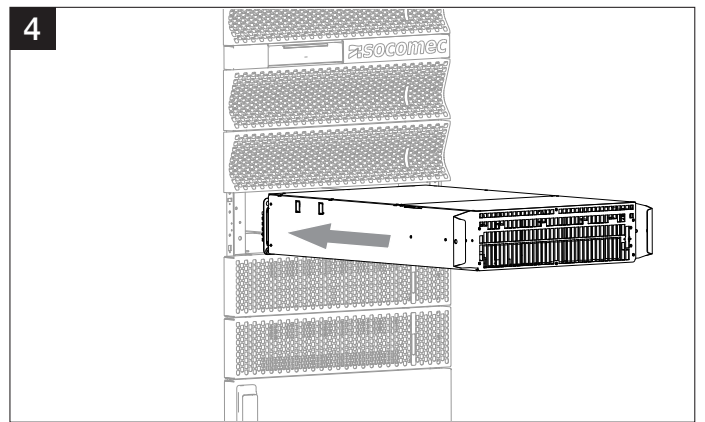
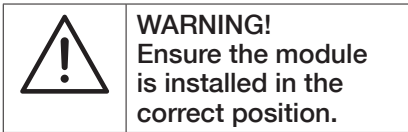
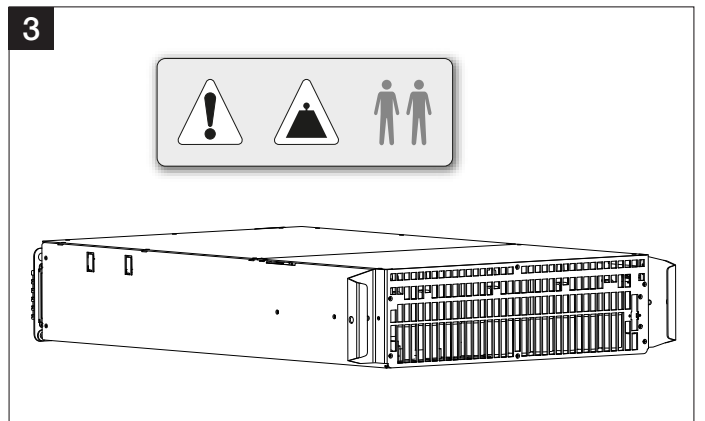
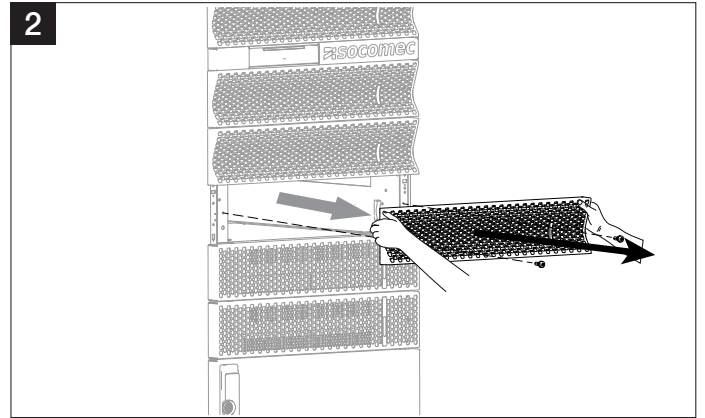
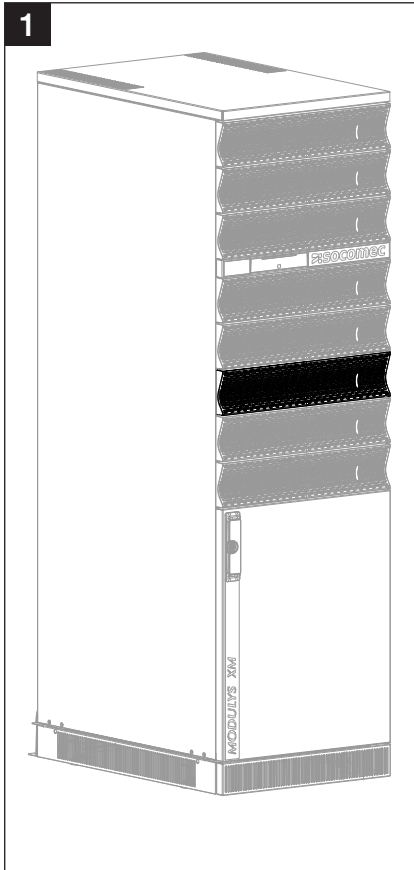

Power module removal



WARNING!
Before removing any module, ensure that the remaining power modules can support the load.

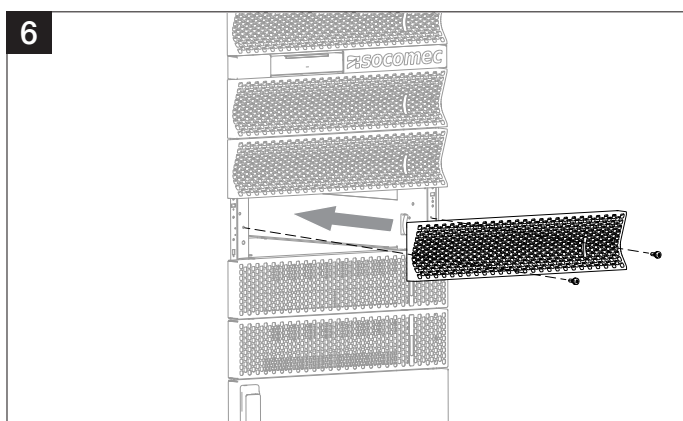
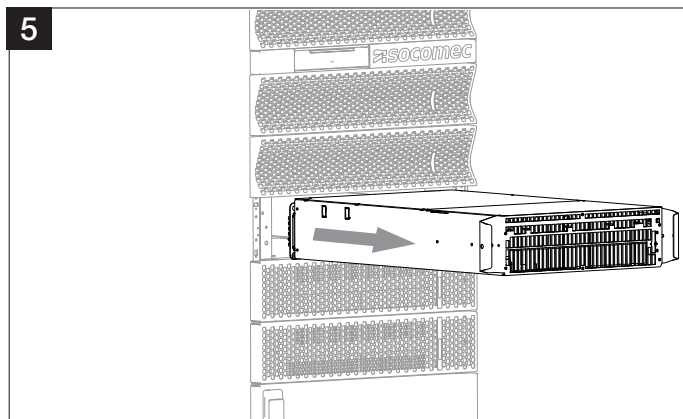
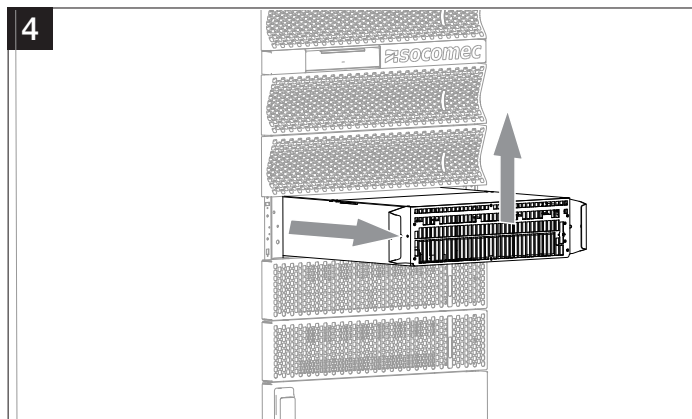
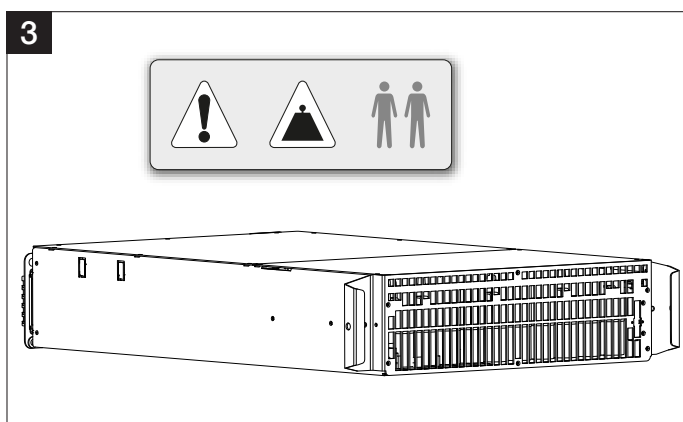
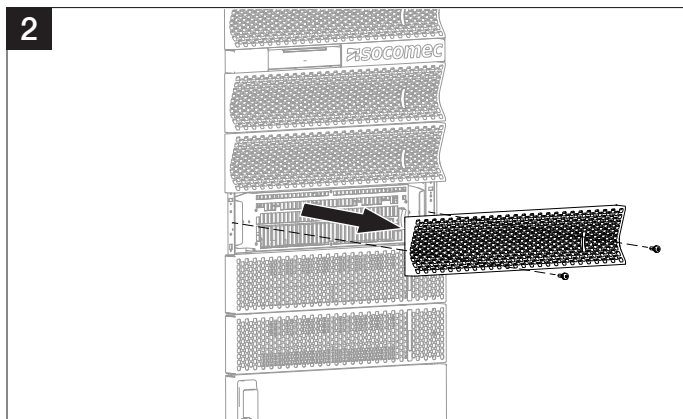
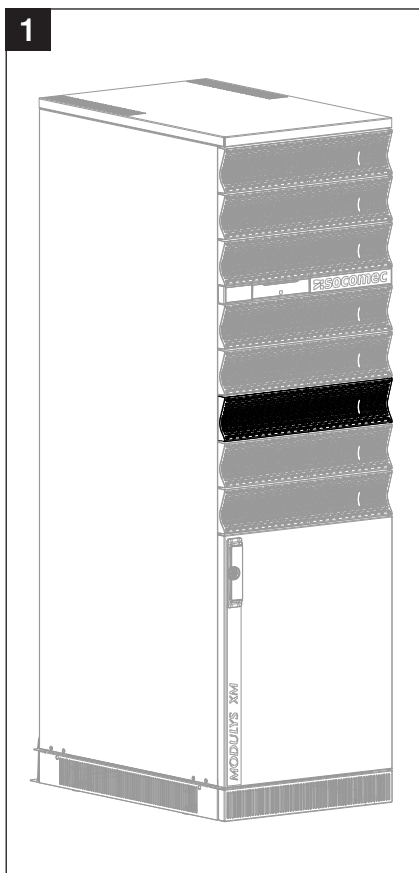

Bypass module replacement



WARNING!
The bypass module replacement can be performed by service personnel only.

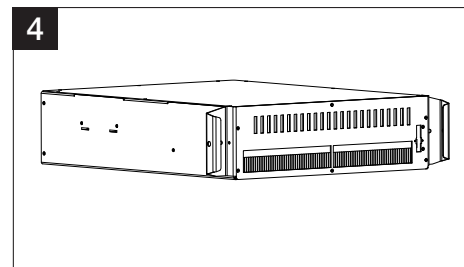
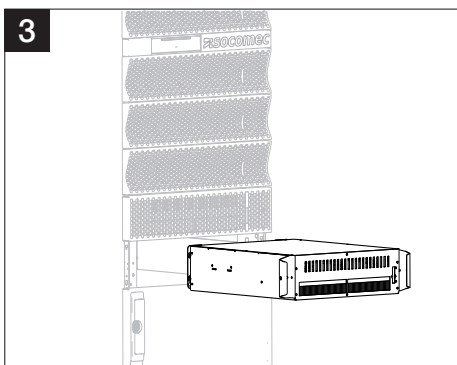
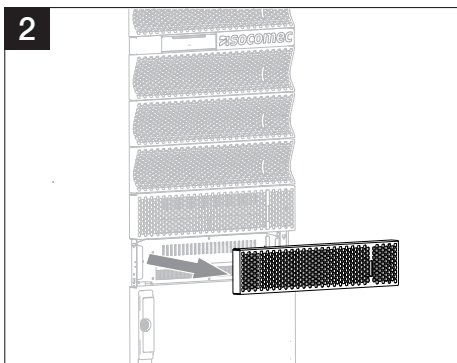
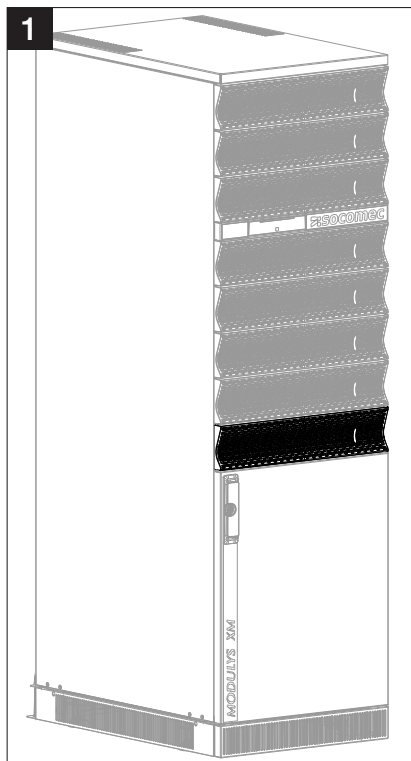

WARNING!
The screws provide protective bonding and avoid unauthorised bypass removal. Tighten the screws to ensure the bonding protection.



DANGER!
Failure to observe this safety instruction could result in fatal accident or serious injury, and damage equipment or the environment.

7. CONTROL PANEL

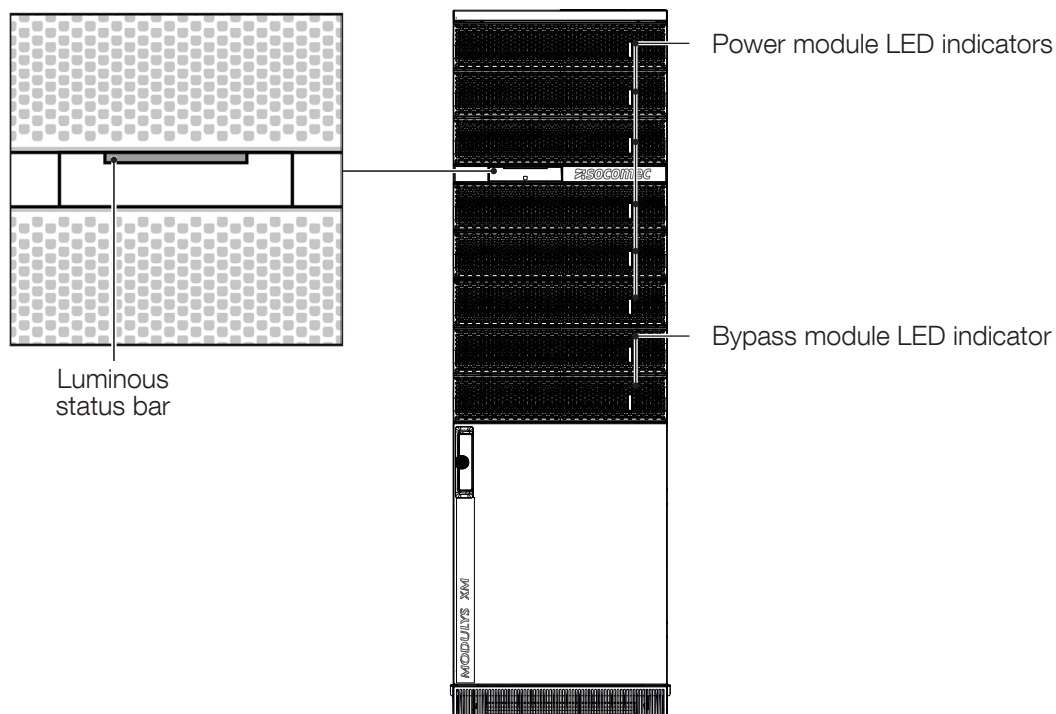

LED indicator		
Colour	Power module	Bypass module
Green	Module on inverter	Bypass ready to start
Flashing green	-	Load on bypass
Yellow	Module ready to start	Maintenance bypass
Flashing yellow	Module initialising	Load on inverter or bypass and transfer impossible/locked
Red	Module stopped due to alert	Bypass alert present
Flashing red	Initialising failure	Bypass blocked with alert
Flashing green yellow and red	No communication	No communication

Control panel luminous status bar indicator	
Colour	Status
Flashing red-yellow-green-red	No communication. The data is no longer updated or not present. Load status cannot be given.
Flashing red	Load supplied, but the output will stop in few minutes.
Red	Load not supplied: Output switched OFF due to an alarm.
Flashing yellow-red	Load supplied, but no longer protected. A critical alarm occurs.
Flashing yellow	Maintenance request / in progress.
Yellow	Load supplied with warning.
Flashing green-yellow-green	Load supplied and preventive alarm present.
Flashing green	Load going to be supplied and testing.
Green	Load protected in inverter.
Grey (OFF)	Load not supplied output on standby / isolated / OFF.

Control panel extraction

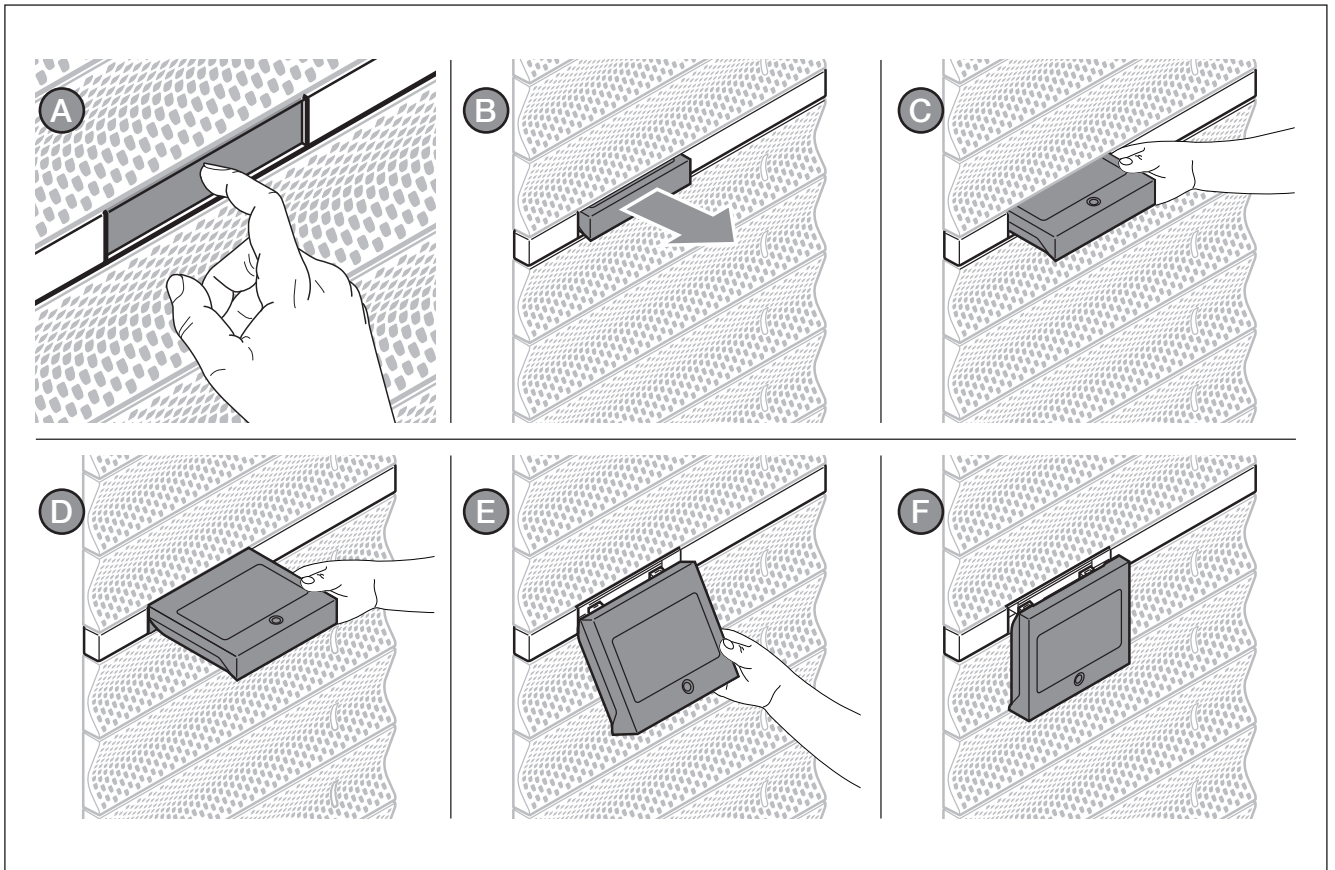

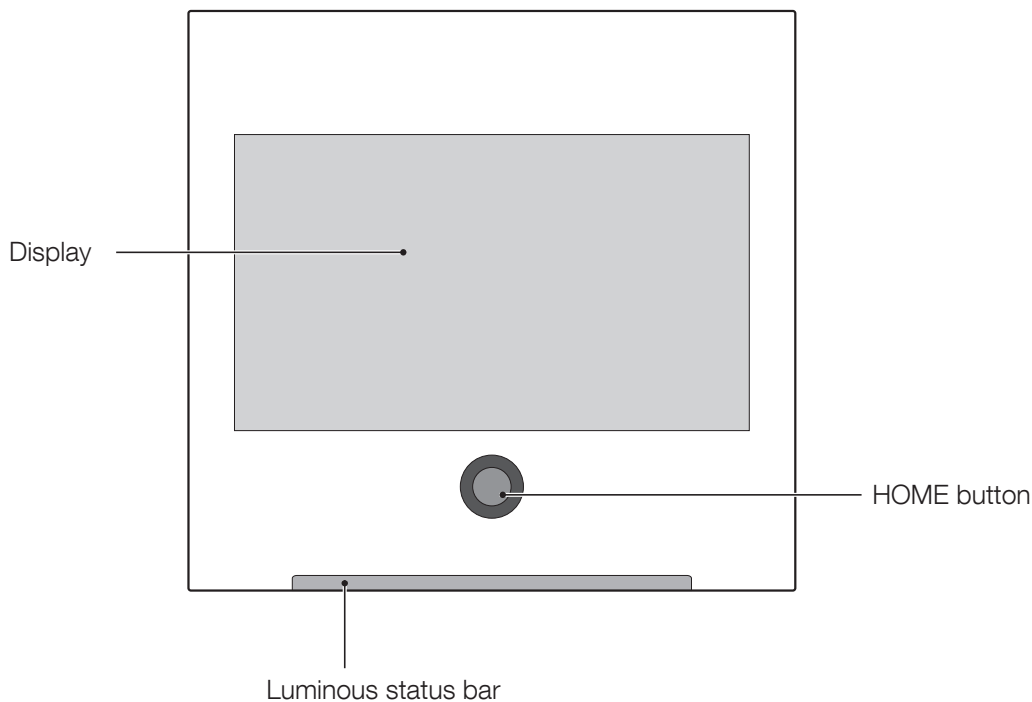

Only two elements are necessary to interact with the unit:

- HOME button: is a mono-stable button used to interact manually with the display especially in emergency situations. Logic behind the interaction is:
 - Single pressing (below 3 sec): HOME page return of graphic display
 - 3 sec < time < 6 sec: change the language to the default (English)
 - 6 sec < time < 8/9 sec: go to the calibration screen automatically
 - Above 8/9 sec: implement the hw reset of the micro controller and restart of the graphic
- Display: is the main active matrix of the display sensitive to touch pressure. The display is designed for rugged industrial applications. The display is single-touch only (no double touch effects). Depending on pressure, the navigation tree and various functions will be executed.

Two special functions are present on the control panel:

- Standby screen: for safety reasons, after a programmable amount of time, the display goes on standby. Display goes to the main screen and touch screen sensitivity is disabled. A label on the bottom of the main screen displays this status. To exit this status press the screen for the HOME button.
- OFF status: for power consumption and life enhancement, after a programmable amount of time display goes in "off". Display goes black and no interaction is possible. Touching the HOME button or screen resumes normal operations.



**Handle the control panel with care. It is made of metal, glass and plastic and contains delicate electronic components. The control panel may be damaged if dropped, pierced or broken or comes into contact with liquids.
Do not use the control panel with a cracked screen, as it may cause injury.**

8. DISPLAY OPERATION

8.1. Display description

Stand alone UPS or unit view:

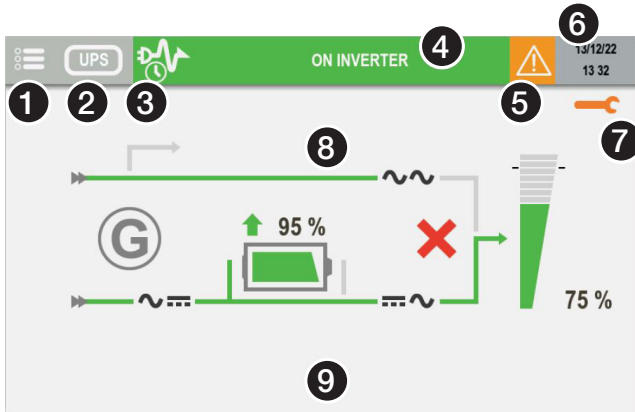

Modules view:

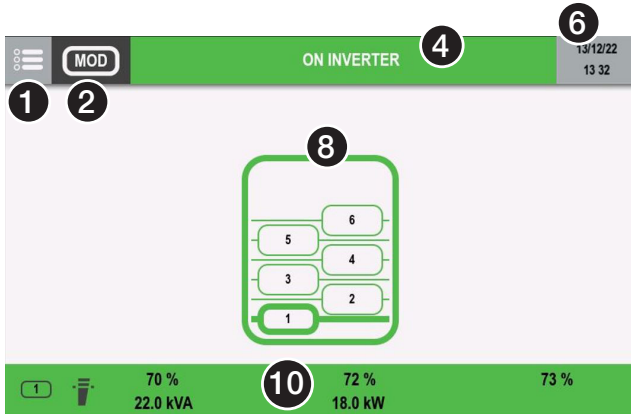

BYPASS view

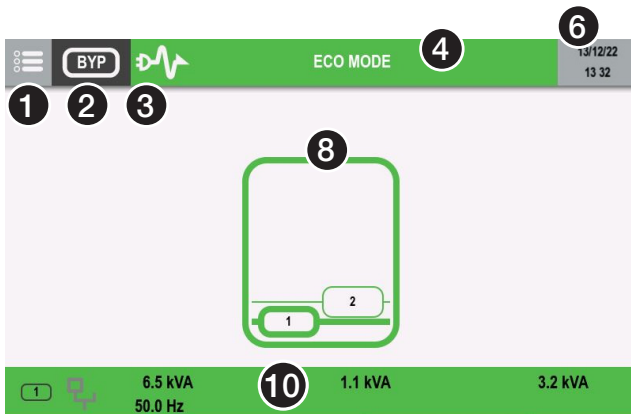

- 1 Menu access
- 2 Device reference
- 3 Functioning mode (see 'Functioning mode' chapter)
- 4 Status displaying / Status page access
- 5 "Alarms" icon appears in case of preventive/critical alarm. A dedicated pop-up appears and can be cleared.
- 6 Clock
- 7 Maintenance alert
- 8 Synoptic area
Help message area
- 9 "Press Key to wake up" appears when the display goes on standby. Touch the display to wake it up.
- 10 Measures report

8.2. Menu architecture

	MENU ITEMS
	Modular Unit [UPS]
MONITORING	
▷ ALARMS	•
▷ STATUS	•
▷ SYNOPTIC	•
▷ UNIT	
▷ SYSTEM	
▷ MODULES OVERVIEW	
▷ MODULE	•
▷ BYPASS	^
EVENTS LOG	•
MEASUREMENTS	
▷ OUTPUT MEASUREMENTS	•
▷ BATTERY MEASUREMENTS	^
▷ INPUT MEASUREMENTS	•
▷ INVERTER MEASUREMENTS	•
▷ BYPASS MEASUREMENTS	^
CONTROLS	
▷ UPS PROCEDURE	
▷ START	• ¹
▷ STOP	• ¹
▷ ON MAINTENANCE BYPASS	• ¹
▷ MODE	
▷ ECO MODE CONTROLS	
▷ ECO MODE ON	^
▷ ECO MODE OFF	^
▷ ECO MODE SCHEDULE	^
▷ ENERGY SAVER CONTROLS	
▷ ENERGY SAVER ON	
▷ ENERGY SAVER OFF	
▷ BATTERY	
▷ BATTERY CONTROLS	
▷ BATTERY TEST	^
▷ BATTERY SCHEDULE	^
▷ MAINTENANCE	
▷ ALARMS RESET	•
▷ POSTPONE MAINTENANCE ALARM	•
▷ LED TEST	•
▷ USER REPORT	•

		MENU ITEMS
		Modular Unit [UPS]
CONFIGURATIONS		
▷ CLOCK		•
▷ COM-SLOTS		
▷ COM-SLOT 1		
▷ COM-SLOT 2		
▷ COM-SLOT 3		
▷ TEMPERATURE PROBE		^
▷ REFERENCE		
▷ SOCOMEC REFERENCE		
▷ SERIAL NUMBER		
▷ USER REFERENCE		
▷ LOCATION		
▷ REMOTE		
▷ REMOTE ON		
▷ REMOTE OFF		
USER PARAMETERS		
▷ LANGUAGE		•
▷ PASSWORD		•
▷ BUZZER		•
▷ DISPLAY		•
▷ PREFERENCES		•
▷ ADC+SL CONFIG		•
▷ TOUCHSCREEN		•
SERVICE		
▷ SERVICE REPORT		•
▷ FW VERSION		•
▷ UPS SETTINGS		
▷ OUTPUT MENU		
▷ OUTPUT VOLTAGE		•
▷ OUTPUT FREQUENCY		•
▷ CONVERTER MODE		•
▷ AUTOMATIC RESTART		•
▷ BATTERY MENU		
▷ BATTERY INSTALLATION		
▷ BATTERY AVAILABLE		^
▷ BATTERY TYPE		^
▷ BATTERY CONNECTION		^

	MENU ITEMS
	Modular Unit [UPS]
▷ BATTERY DATA	
▷ CAPACITY	^
▷ N° OF CELLS	^
▷ N° OF BLOCKS	^
▷ RECHARGE TYPE	^
▷ PREMIN. VOLTAGE	^
▷ MIN. VOLTAGE	^
▷ FLOATING	^
▷ BOOST VOLTAGE	^
▷ BATTERY THRESHOLDS	
▷ RECH. CURR. LIMIT	^
▷ FLOAT-BOOST THRESHOLD	^
▷ BOOST-FLOAT THRESHOLD	^
▷ TEMP.COMPENSATION	
▷ TEMPER.COMPENSATION	^
▷ TRANSFORMER MENU	
▷ INPUT TRANSFORMER	•
▷ OUTPUT TRANSFORMER	•
▷ AUX TRANSFORMER	•
▷ INPUT TRASFO VOLTAGE	•
▷ OUTPUT TRASFO VOLTAGE	•
▷ AUX TRASFO VOLTAGE	•
▷ MAINS CONFIGURATION	
▷ MAINS CONFIGURATION	•
▷ REDUNDANCY	
▷ NOMINAL NUMBER OF MODULES	
▷ REDUNDANCY LEVEL	
▷ NETWORK PARAMETERS (ONLY FOR SERVICE)	
▷ DHCP	•
▷ IP	•
▷ MASK	•
▷ GATEWAY	•
▷ MAC (READY ONLY)	•

(^) Depending on setting

(1) Displayed depending on state

8.3. Functioning mode



Service



Isolated



Eco mode scheduling active



Eco Mode active



Standby active



Energy saver active



Autotest

8.4. Status

8.4.1. Status page

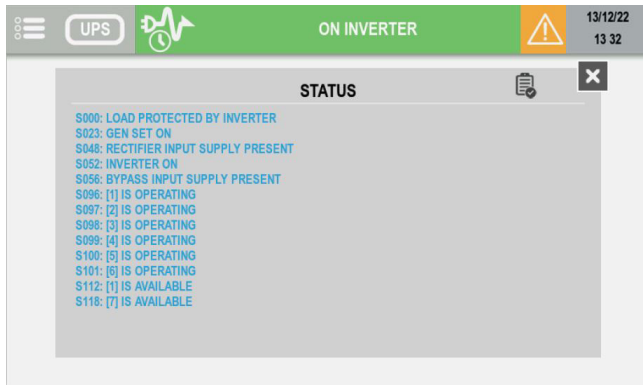

Filtering



List all active status



List all status



List all status not active

8.5. Alarms management

8.5.1. Alarm report

The alarm icon is present if at least one alarm is present.

Tap on the icon to open the alarm list.

8.5.2. Alarm popup

In case of critical alarm a popup message appears and the buzzer is running according its settings.

The highest priority alarm is displayed.



Tap on valid button to stop the buzzer and to close the popup message. The alarm page is automatically display after this action.

8.5.3. Alarm page

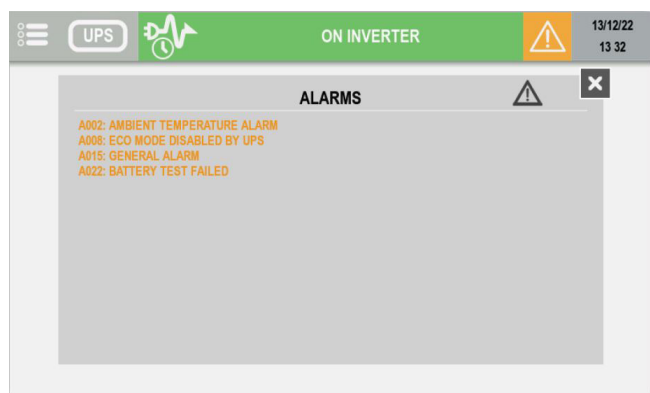

Filtering



List all active alarms



List all active preventive alarms



List all active critical alarms









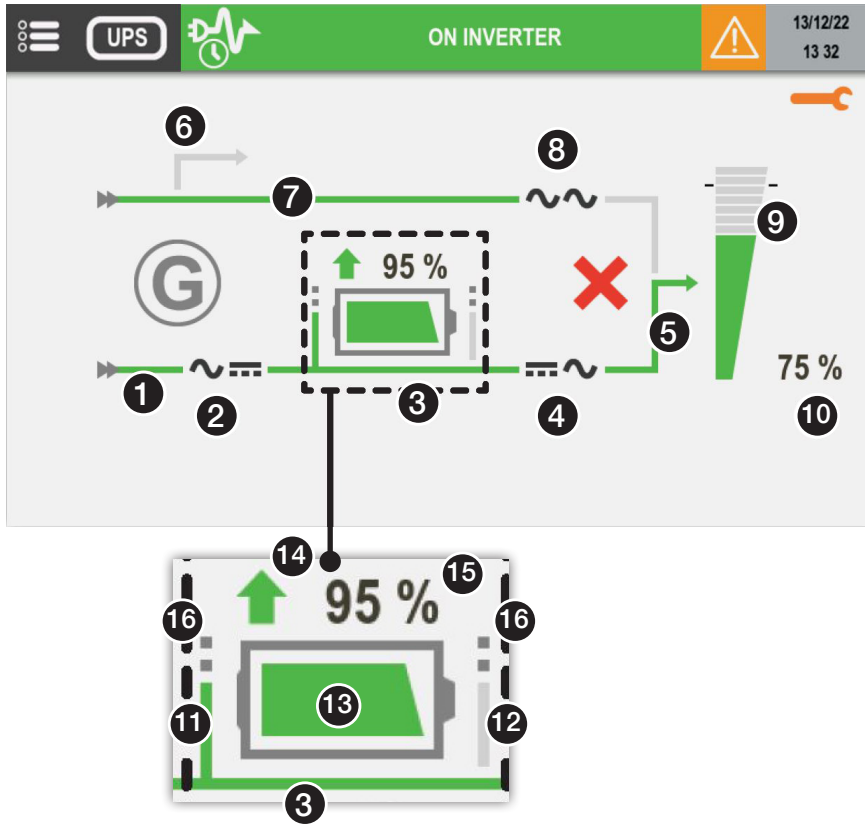









POPUP ALARM FOR PREVENTIVE ALARM

In USER PARAMETERS menu, PREFERENCES item gives the possibility to enable popup alarm also with preventive alarms.

8.6. Synoptic animation

- Stand alone UPS or unit view



Item	Description	Rules of animation				Touch actions
		Grey	Green	Yellow	Red	
1	Rectifier input supply	Not present	Present	Out of tolerance	-	-
2	Rectifier status	Normal status	-	Preventive alarm	Critical alarm	Access to input measurements page
						
3	DC voltage bus	DC voltage absent	DC voltage presence	-	-	-
4	Inverter status	Normal status	-	Preventive alarm	Critical alarm	Access to inverter measurements page
						
5	Inverter output	Inverter OFF	Inverter ON	Inverter on battery	-	-
6	Maintenance bypass *	MBP present	-	Load on maintenance bypass	-	-
7	Bypass input *	Not present	Present	Out of tolerance	-	-
8	Bypass status *	Normal status	-	Preventive alarm	Critical alarm	Access to bypass page
						
9	Load rate symbol	No load	Fill-up to 95%	Fill-up to 110%	Fill-up over 110%	Access to output measurements pages
						
10	Load rate value	Instantaneous value. displayed if value > 0				-
11	DC battery input **	DC voltage absent	DC voltage presence	BCR function running	-	-
12	DC battery output **	DC voltage absent	DC voltage presence	Inverter on battery	-	-
13	Battery indicator **	-	Fill-up to 100%	Fill-up to 45%	Fill-up to 15%	Access to bat. measurements page
						
14	Battery charging / discharging **	-	Battery charging	Battery discharging	-	-
						
15	Battery level or remaining backup time during battery discharge **	Instantaneous value. displayed if value > 0 The backup time is no more displayed if it is below two minutes.				-
16	Shared battery symbol not present if each unit has its own battery. **					-

* Element disappears if converter mode is active

** Not present if batteries are not present

• Battery animation

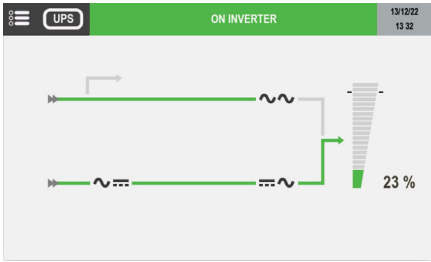
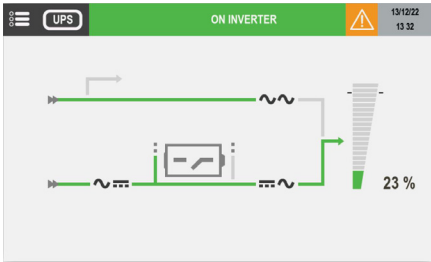
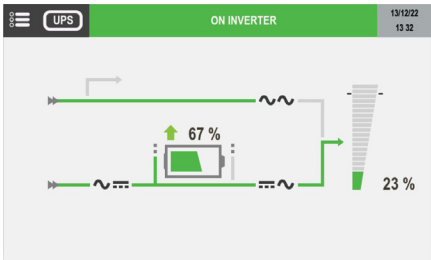
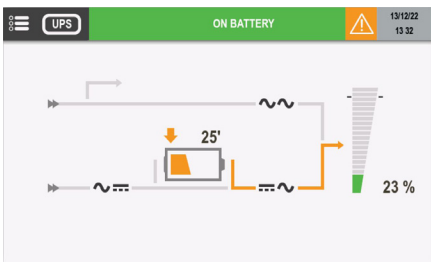
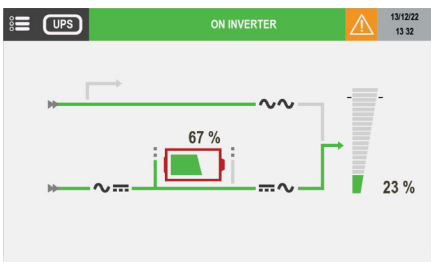
BATTERY STATUS	DESCRIPTION
	<p>If battery is absent, the battery icon is not displayed</p>
	<p>If battery is present but not connected, the icon is displayed</p>
	<p>If the battery is present and charging, the arrow icon is displayed</p>
	<p>If the battery is present and discharging, the arrow icon is displayed</p>
	<p>If a battery alarm has occurred, the red icon is displayed</p>

8.6.1. Additional icons



Bypass impossible.



Bypass locked.



“Genset Mode” when the gen set contact is active. Need ADC+SL correctly configured.



Maintenance alarm.

Preventive maintenance is requested.

8.7. Event log page

Date	Time	Code	Description	Status
13/12/16	08:30:00	S000	LOAD PROTECTED BY INVERTER	NO
31/12/16	08:31:05	S112	[!] IS AVAILABLE	YES
31/12/16	08:31:07	A032	RECTIFIER CRITICAL ALARM	YES
31/12/16	08:31:09	A064	PROGRAMMABLE A064	YES
16/01/17	12:25:00	A208	PROGRAMMABLE S079	YES
17/01/17	13:40:00	A176	ALL UNITS OR MODULES ARE AVAILABLE	YES
18/01/17	16:30:00	S000	LOAD PROTECTED BY INVERTER	NO
25/01/17	00:15:00	A016	BATTERY DISCONNECTED	YES
15/01/17	10:20:00	S000	LOAD PROTECTED BY INVERTER	NO
18/01/17	16:30:00	S096	[!] IS OPERATING	NO



Show STATUS events



Show ALARMS events



Show CONTROLS

8.8. Menu function descriptions

8.8.1. Entering passwords

Some operations and settings require a password in order to be performed.

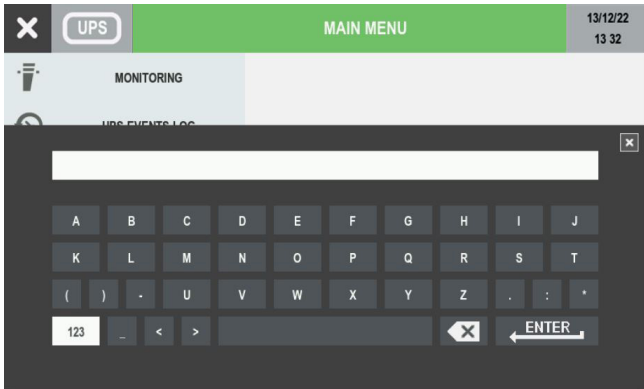

Wildcard covering of the password is active by default.

The default password is **SOCO**.



NOTE!

The password must only contain capital letters and not include the following characters ():*<>._

Press **ENTER** to confirm the selection or close the window to abort.

8.8.2. MONITORING menu

Submenu Alarm opens the alarm pages.

Submenu Status opens the status pages.

8.8.3. EVENTS LOG menu

This menu accesses the event log (Status and Alarms).

8.8.4. MEASUREMENTS menu

This menu displays all UPS measurements relating to the rectifier input stage, output stage, batteries, bypass input stage and inverter.

The pins on the bottom of the screen indicate whether or not there are more pages. Sliding to the right or left changes measurements page.

8.8.5. CONTROLS menu

This menu contains the commands that can be sent to the UPS. Some of them are password protected. If a command is not available, a COMMAND FAILURE message appears.

- **UPS PROCEDURE: START/ON MAINTENANCE BYPASS/STOP** see 'Operating procedures' chapter.
- **BATTERY: BATTERY CONTROLS > BATTERY TEST:** this function checks whether or not test conditions are available and returns the results.
- **MODE: ECO MODE CONTROLS:** this function sets/resets the **ECO MODE**.
- **MAINTENANCE: Alarms reset:** this function clears the alarm history, **LED test:** this function activates LED flashing for a few seconds.

8.8.6. UPS CONFIGURATION menu

- **CLOCK:** this function sets the date and time.
- **COM-SLOTS:** this function configures the RS485 modbus serial link.
- **REFERENCE:** this function gives the possibility to customised the unit reference and the location.
- **REMOTE:** this function enables controls from remote devices through MODBUS protocol (NET VISION for example).

8.8.7. USER PARAMETERS menu

This menu contains the different functions for users such as language, password, buzzer, display, preferences, touchscreen calibration.

8.8.8. SERVICE menu

This menu is reserved for support service personnel and holds UPS identification data and utilities for software upgrades.

- **UPS SETTINGS:** critical machine settings for output. Some parameters cannot be modified when the UPS supplies the load by INVERTER or BYPASS.



Wrong configuration in UPS SETTINGS could damage the load or the batteries.

8.9. Additional user functions

8.9.1. Phase colour modification

- Enter **MAIN MENU > USER PARAMETERS > PREFERENCES**

For each phase is possible to select a specific colour in a set of colour range. Those colours are applying in the measurements pages.

Colour	Default colour
 Yellow	Phase 3
 Orange	
 Red	
 Green	
 Light blue	Phase 2
 Dark blue	
 Purple	Phase 1
 Brown	
 Light grey	
 Dark grey	
 Black	

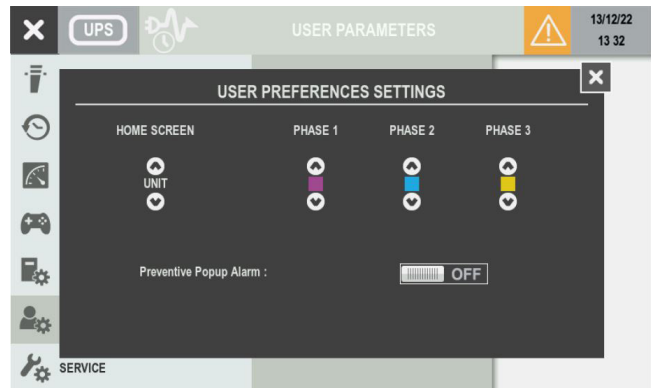

The popup alarm appears in case of critical alarms. This function can be extended to preventive alarms by switching “Preventive Popup Alarm” to ON.

9. OPERATING PROCEDURES



NOTE: before carrying out any operations on the unit read the 'Safety standards' chapter carefully.



NOTE: with the stop procedure the load will be disconnected.

9.1. Switching on

- Connect the mains and auxiliary mains to the UPS.
- Put switch **Q1** (or the external input mains switching device) into position **1**.
- Wait for the display to switch on.
- Enter **MAIN MENU > CONTROLS > UPS PROCEDURE**.
- Select **START** and press **ENTER**.
- Carry out the operations indicated on the display.

9.2. Switching off

This operation interrupts the power supply to the load. The UPS and the battery charger will be shutdown.

- Enter menu **MAIN MENU > CONTROLS > UPS PROCEDURE**.
- Select **STOP** and press **ENTER**.
- Wait approx. 2 minutes for the UPS shutdown.



NOTE: the controlled shutdown of each server connected to the LAN can be managed by shutdown software (only with Net Vision option card).

- Carry out the operations indicated on the display. This operation cannot be aborted.

9.3. Bypass operations

Switching onto maintenance bypass

This operation creates a direct connection between the UPS input and output, excluding the equipment control part. This operation is performed in the event of:

- standard maintenance.
- serious failure has occurred.



WARNING! LOAD POWERED BY AUXILIARY MAINS!
Your load is exposed to mains disturbances.

- Enter menu **MAIN MENU > CONTROLS > UPS PROCEDURE**.
- Select **ON MAINTENANCE BYPASS** and press **ENTER**.
- Carry out the operations indicated on the display.



NOTE!
When an external manual bypass is present:

- carry out the procedure described above
- put the switch to position 1

Switching on from maintenance bypass

- Put switch **Q1** into position **1 (MAINS ON)**.
- Wait for the display to switch on.
- Enter menu **MAIN MENU > CONTROLS > UPS PROCEDURE**.
- Select **START** and press **ENTER**.
- Carry out the operations indicated on the display.



NOTE!

When an external manual bypass⁽¹⁾ is present, connect a normally-closed early make contact from the External Maintenance bypass switch to the dedicated connector.

(1) if a normally-closed early make contact is not available, the external manual bypass must be open just before opening Q5 when requested from procedure.

9.4. Extended out of service

When the UPS is deactivated for some time, the batteries must be recharged regularly.

They should be recharged every three months.

- Check that output switches Q3 and Q5 are OFF.
- Connect the mains and auxiliary mains to the UPS.
- Switch ON input switch Q1.
- Wait until displays switch on.
- Enter menu **MAIN MENU > CONTROLS > UPS PROCEDURES**.
- Select **START** and press **ENTER**.
- Carry out the operations indicated on the display.
- Close the external battery breaker/fuses.
- Wait until the batteries are fully charged. Check in the menu **MAIN MENU > MEASUREMENTS > BATTERY MEASUREMENTS**.
- Open the external battery breaker/fuses.
- Switch OFF input switch Q1.

9.5. Emergency shutdown



NOTE!

This operations interrupts the supply to the output load from both inverters and automatic bypass.

Ups power off

- Put Q3 to position 0 when it's necessary to interrupt the power supply quickly.

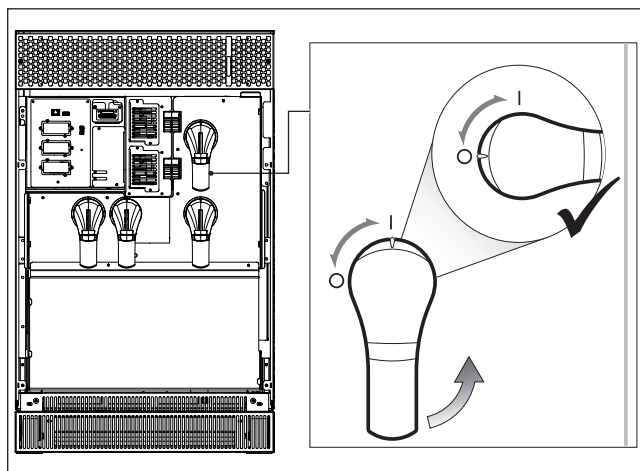

Remote ups power off

It is possible to interrupt the power supply to the output load using the ADC+SL board. Refer to 'Standard features and option' chapter.

10. OPERATING MODES

10.1. On line mode

A special feature of the UPS is the ONLINE double conversion in conjunction with low distortion mains power absorption. In ON LINE mode, the UPS can supply a voltage that is fully stabilised in frequency and amplitude, regardless of any interference in the mains power supply, within the most stringent classification of UPS regulations.

ONLINE operation provides three operating modes according to mains and load conditions:

- **Inverter mode**

This is the most frequent operating condition: energy is drawn from the primary mains power supply and converted and used by the inverter to generate the output voltage to power the connected loads.

The inverter is constantly synchronised in frequency with the auxiliary mains to enable load transfer (due to an overload or inverter shutdown) without any break in the power supply to the load.

The battery charger supplies the energy required to maintain or recharge the battery.

- **Bypass mode**

In the event of inverter failure, the load is automatically transferred onto the auxiliary mains without any interruption in the power supply.

This procedure may occur in the following situations:

- in the event of a temporary overload, the inverter continues to power the load. If the condition persists, the UPS output is switched
 - on to the auxiliary mains via automatic bypass. Normal operation, which is from the inverter, returns automatically a few seconds after the overload disappears.
 - when the voltage generated by the inverter goes outside the limits due to a major overload or a fault on the inverter.
 - when the internal temperature exceeds the maximum value allowed.
- **Battery mode**

In the event of a mains failure (micro interruptions or extended power cuts), the UPS continues to power the load using the energy stored in the battery.

10.2. High efficiency mode

The UPS has a selectable, programmable economy operating mode (ECO MODE) that can increase overall efficiency by up to 99% for energy saving purposes. If the power supply fails, the UPS will automatically switch onto the inverter and continue to supply power to the load by drawing energy from the battery.

This mode does not provide perfect stability in frequency and voltage like the NORMAL MODE. Therefore the use of this mode should be carefully evaluated according to the level of protection required by the application. With the optional board Net Vision specific daily or weekly time intervals can be selected and programmed to power applications directly from the auxiliary mains.

ECO MODE operation provides very high efficiency, since the application is powered directly from the auxiliary mains via the automatic bypass under normal operating conditions.

To activate follow the correct procedure in the control panel.

10.3. Converter mode

In converter mode the UPS can supply a fully stabilised sinusoidal output voltage with a different frequency from the input power line (50 Hz or 60 Hz is available as output frequency value).

**NOTE!**

Only set this mode on UPS units with the auxiliary mains (AUX MAINS) disconnected! Do not set this mode on UPS units with common mains lines as it could damage the load!

10.4. Operation with maintenance bypass

If the internal maintenance bypass is activated using the appropriate procedure, the load is powered directly from the maintenance bypass, while the UPS is separate from the power supply and can be switched off.

This operating mode can be selected for maintenance to be carried out on the system, so that the necessary actions can be performed by service personnel without having to disconnect the power supply to the load.

10.5. Operation with motor generator (GENSET)

The UPS can be operated in conjunction with a generator (GENSET) over the ADC+SL card (refer to 'Standard features and option' chapter). With a generator, the frequency and voltage ranges of the auxiliary mains can be increased to accept the instability of the GENSET and at the same time to avoid operation from the battery or risks of out-of-synchronisation switching on to the bypass.

11. STANDARD FEATURES AND OPTION

Availability	
●	Factory-installed option
○	Available as option
-	Not available
STD	Standard feature

Features	MODULYS XM	Compatibility
Communication Option		
ADC+SL card	○	
LIB-ADC <i>(Lithium Ion Battery interface)</i>	○	
Temperature sensor	○	⚠️ ⓘ ADC+SL card
Net Vision card	○	
EMD	○	⚠️ ⓘ Net Vision card
ACS card	○ ●	
Modbus TCP card	○	
BACnet card	○	
Remote touchscreen display	○	⚠️ ⓘ ADC+SL card
PROFIBUS protocol interface	○	⚠️ ⓘ ADC+SL card
Mechanical Option		
Top air exhausted	○	⚠️ ⓘ ADC+SL card
Top entry cables	○	
Anti-vermin protection	STD	
Electrical Option		
Kit for common mains	○	
Kit for TN-C / Neutral-Ground connection	○ ●	
Seismic kit	●	⚠️ 🚫 Top entry cables
Other		
Cold start	○ ●	

ⓘ Required option

🚫 Incompatible option

11.1. ADC+SL card

The ADC+SL (Advanced Dry Contact + Serial Link) is a slot optional board that provides:

- 4 relays for external device activation (can be set as normally closed or normally open).
- 3 free inputs to report external contacts to UPS.
- 1 connector for external battery temperature sensor (optional).
- RS485 insulated serial link providing MODBUS RTU protocol.
- 2 LEDs indicating board status.

The board is plug&play: the UPS is able to recognise its presence and configuration (up to 4 standard operating modes can be selected by the display) and manages the ADC+SL outputs and the inputs accordingly. It is possible to create a custom operation mode through after sales service.

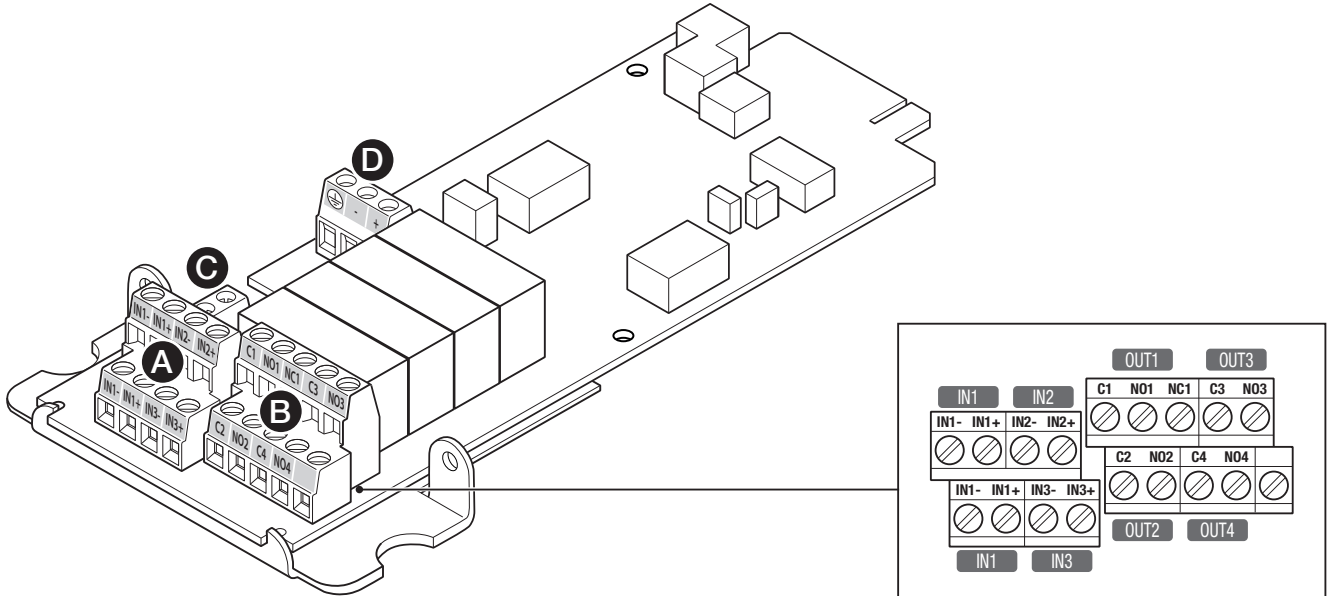

KEY

- A 3 free inputs to link external contacts to UPS.
- B 4 relays for external device activation.
- C 1 connector for external temperature sensor.
- D RS485 insulated serial link.



NOTE!

If the board is removed while operating, an alarm is flagged on the control panel. Perform an "Alarm reset" control to cancel it.

Input

- Free voltage loop.
- INx+ has to be connected to INx- to close the loop on XB4 connector.
- Inputs must be isolated with basic insulation from a primary circuit up to 277 V.
- IN1 is duplicated, giving the possibility to link the UPS POWER OFF signal to other equipment, for example.

Relay outputs

- Contact voltage guaranteed at 277 V (AC) / 25 V (DC) – 4 A (for higher voltage, please contact the manufacturer).
- Relay 1 gives the possibility of choosing between normally closed (NC1) or normally open (NO1) position. Relays 2, 3 and 4 only have normally open position (NOx).
- On connector XB3, Cx means common, NOx means normally open position.

STANDARD configuration (default)					
IN/OUT	DESCRIPTION	ACTIVATION DELAY (s)	REMARK ⁽¹⁾	INPUT TYPE	STATE
IN1	UPS POWER OFF	1	Command sent to UPS ⁽²⁾	Close to activate	Normally open
IN2	GEN SET ON	1	Activate S023 status	Open to activate	Normally close
IN3	INSULATION FAULT	10	Activate A026	Open to activate	Normally close
RELAY 1	GENERAL ALARM	10	(NC1 or NO1 position can be chosen) Relating to A015		Normally open/close
RELAY 2	OPERATING ON BATTERY	30	Relating to A019		Normally open
RELAY 3	END OF BACK-UP TIME	10	Relating to A017		Normally open
	IMMINENT STOP	10	Relating to A000		Normally open
RELAY 4	LOAD SUPPLIED BY AUTOMATIC BYPASS	10	Relating to S002		Normally open

OPTIONS SUPERVISOR configuration					
IN/OUT	DESCRIPTION	ACTIVATION DELAY (s)	REMARK ⁽¹⁾	INPUT TYPE	STATE
IN1	UPS POWER OFF	1	Command sent to UPS ⁽²⁾	Close to activate	Normally open
IN2	FAN FAILURE	10	Activate A054	Close to activate	Normally open
IN3	BATTERY DISCONNECTED	10	Activate A016	Open to activate	Normally close
RELAY 1	GENERAL ALARM	10	(NC1 or NO1 position can be chosen) Relating to A015		Normally open/close
RELAY 2	OPERATING ON BATTERY	30	Relating to A019		Normally open
RELAY 3	REDUNDANCY LOST	10	Relating to A006		Normally open
RELAY 4	BATTERY DISCONNECTED	1	Relating to A016		Normally open

SAFETY configuration					
IN/OUT	DESCRIPTION	ACTIVATION DELAY (s)	REMARK ⁽¹⁾	INPUT TYPE	STATE
IN1	UPS POWER OFF	1	Command sent to UPS ⁽²⁾	Close to activate	Normally open
IN2	INSULATION FAULT	1	Activate A026	Open to activate	Normally close
IN3	CHARGER DISABLE/ ENABLE	10	Command sent to UPS ⁽²⁾	Open to activate	Normally close
RELAY 1	GENERAL ALARM	10	(NC1 or NO1 position can be chosen) Relating to A015		Normally open/close
RELAY 2	UPS POWER OFF	1	Relating to A059		Normally open
RELAY 3	END OF BACK-UP TIME	10	Relating to A017		Normally open
	IMMINENT STOP	10	Relating to A000		Normally open
RELAY 4	INSULATION FAULT	1	Relating to A026		Normally open

ENVIRONMENTAL configuration					
IN/OUT	DESCRIPTION	ACTIVATION DELAY (s)	REMARK ⁽¹⁾	INPUT TYPE	STATE
IN1	UPS POWER OFF	1	Command sent to UPS ⁽²⁾	Close to activate	Normally open
IN2	PROGRAMMABLE ALARM	10	Activate A064	Open to activate	Normally close
IN3	BATTERY TEMPERATURE ALARM	10	Activate A020	Open to activate	Normally close
RELAY 1	GENERAL ALARM	10	(NC1 or NO1 position can be chosen) Relating to A015		Normally open/close
RELAY 2	BATTERY TEMPERATURE ALARM	10	Relating to A020		Normally open
RELAY 3	REDUNDANCY LOST	10	Relating to A006		Normally open
	OVERLOAD	10	Relating to A001		Normally open
RELAY 4	PROGRAMMABLE ALARM	10	Relating to A064		Normally open

(1) The acronyms mentioned are linked to MODBUS table (Snnn=Status/Annn=Alarm).

(2) A self-locking emergency push button must be used for the UPS Power Off input.

Note: custom configuration is also available. For more information contact Socomec.

RS485 serial link

- Insulated RS485, protected against over voltage. Only for local bus purposes; maximum ~500 m.
- Pull up and pull down line resistor XJ1 (failsafe biasing): jumper open by default.
- Possibility of fixing the RS485 cable to the board.
- Cable type required: twister pair cable + shield to connect to ground. (AWG 24, 0.2 mm² for example).

The INPUT and RELAYS are managed with information coming from the UPS.



NOTE!

**Inputs and relays can be re-programmed depending on requirements.
Contact your SOCOMEC after-sales service to change Input/Output programming.**

Information coming from inputs can be reported in the UPS database for display on the mimic panel and is accessible on the MODBUS table.

The UPS can manage up to three ADC+SL option cards. The cards can be re-programmed for other uses.

In this specific case, the 3 serial links (SLOT 1, SLOT 2 and SLOT 3) are independent.

Modbus serial link

The RS485 provides MODBUS RTU protocol.

The description of MODBUS addresses and UPS database are described in the MODBUS user manual. All manuals are available on SOCOMEC's web site (www.socomec.com).

Serial link settings

COM1 relates to serial port on board in SLOT 1.

COM2 relates to serial port on board in SLOT 2.

COM3 relates to serial port on board in SLOT 3.

Settings are available via the mimic panel to configure:

- Baud rate.
- Parity.
- MODBUS slave number.

Board status

Board presence is reported through status S064 for slot 1, S065 for slot 2 and S068 for slot 3.

In the case of board failure, 'Option board alarm' (A062) occurs to prevent malfunctioning.

11.1.1. Temperature sensor

The temperature sensor can be used to monitor the battery temperature.

The ADC+SL card can be ordered with or without the temperature sensor in kit.

Temperature range: 0 °C to 40 °C.

11.2. LIB-ADC card

The LIB-ADC (Lithium Ion Battery interface) is a slot optional board that provides:

- 4 relays for external device activation (can be set as normally closed or normally open)
- 3 inputs to report external contacts to UPS
- 1 connector for external temperature sensor (optional)
- RS485 insulated serial link providing MODBUS RTU protocol
- 4 leds indicating the board status and RS485 communication status

The input and output connections of this card are exclusively reserved for the LIB interface: they cannot be used for general purposes. Setting up the UPS and activation of the system must be done by qualified technicians.

Please contact the SOCOMEC service centre.

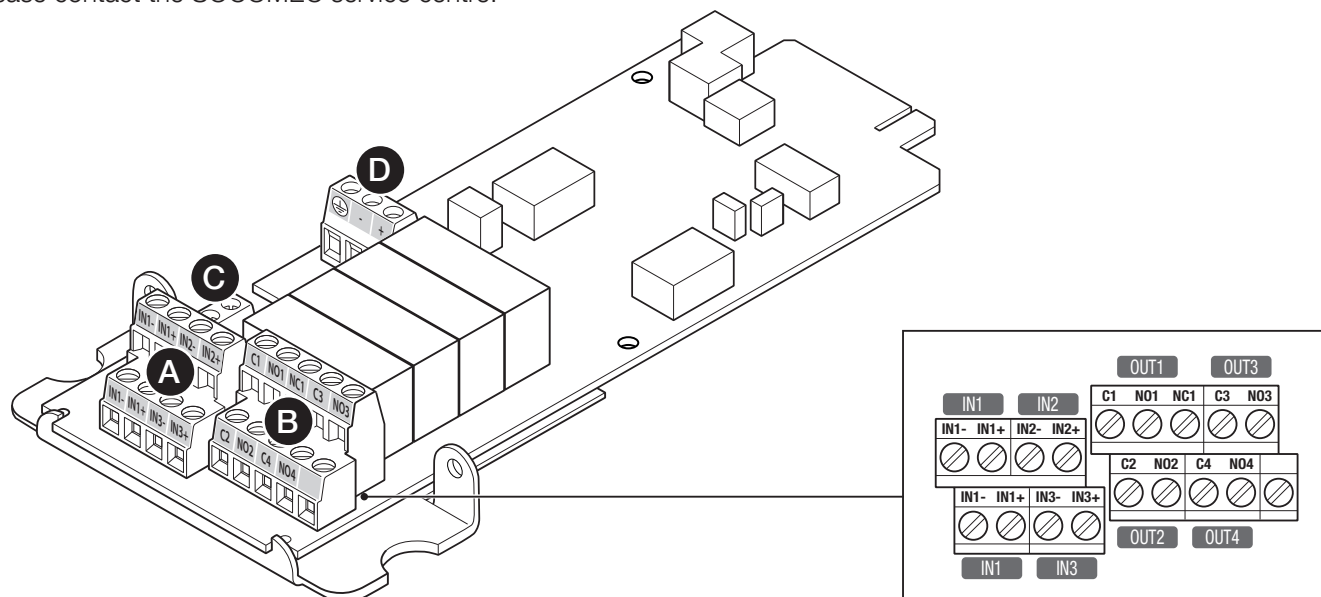

KEY

- | | |
|---|---|
| <p>A 3 inputs to link external contacts to UPS
XB4 (reserved for LIB interface)</p> <p>B 4 relays for external device activation
XB3 (reserved for LIB interface)</p> | <p>C 1 connector for external temperature sensor
XB2 (reserved for LIB interface)</p> <p>D RS485 insulated serial link
XB1 (reserved for LIB interface)</p> |
|---|---|

DESCRIPTION

- Auto detect of the BMS connected.
- Smart interface with LIB system, thanks to the serial connection.
- Easy connection and configuration.
- BMS data tunneling feature for building management system.

11.3. Net Vision card

NET VISION is a communication and management interface designed for business networks. The UPS behaves exactly like a networked peripheral, it can be managed remotely, and allows the shutdown of network workstations.

NET VISION allows a direct interface between the UPS and LAN network avoiding dependence on the server and support SMTP, SNMP, DHCP and many other protocols. It interacts via the web browser.

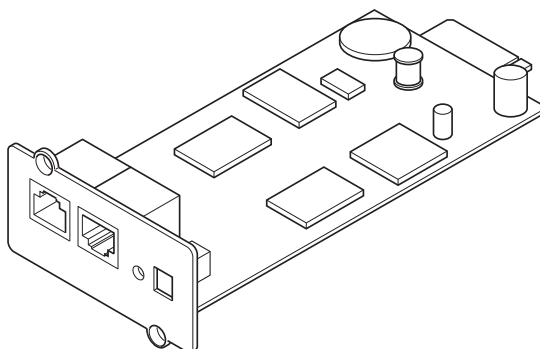

11.3.1. EMD

EMD (Environmental Monitoring Device) is a device to be used in conjunction with the NET VISION interface and provides the following features:

- temperature and humidity measurements + dry contact inputs,
- alarm thresholds configurable via Web browser,
- notification of environmental alarm via email and SNMP traps.

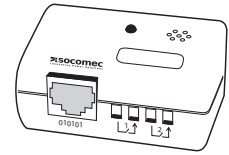

11.4. ACS card

ACS (Automatic Cross Synchronisation) card is used to receive a synchronisation signal from an external source and manage it for the UPS where it is installed, and provide a synchronising signal, where requested, to another UPS.

11.5. Modbus TCP card

With the MODBUS TCP card fitted in the options slot, the UPS can be monitored from remote stations using the appropriate protocol (MODBUS TCP - IDA).

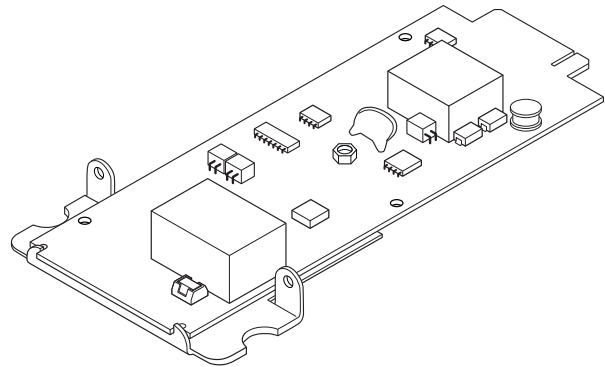

11.6. BACnet card

With the BACnet card fitted in the options slot, the UPS can be monitored from remote stations using the appropriate protocol (BACnet - IDA).

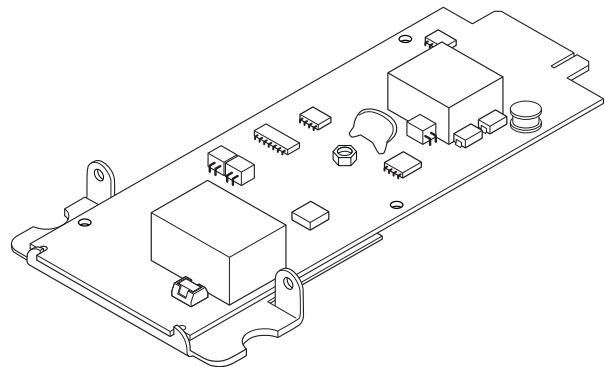

11.7. Remote touchscreen display

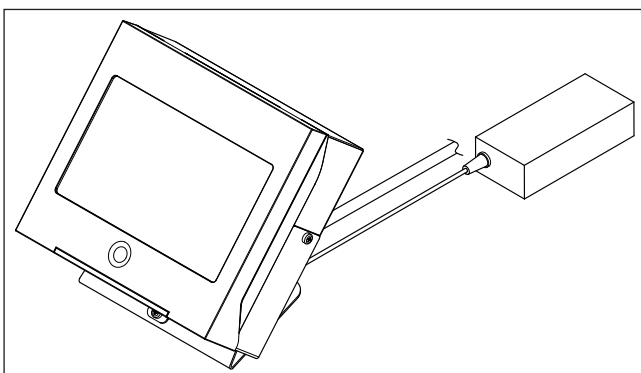

NOTE!
Available only with ADC+SL option card.

11.8. PROFIBUS protocol interface

Socomec UPS can be provided with an interface of PROFIBUS ® DP slave type for the UPS to be connected to a PROFIBUS ® PLC.

PROFIBUS ® protocol is aimed at exchanging data between input/output monitoring devices and a master unit.

The frame exchanged with the PLC only manages input data comprising a maximum of 255 bytes. Controls that are considered as output data are not managed by means of the PROFIBUS ® coupler.

11.9. Top air exhausted

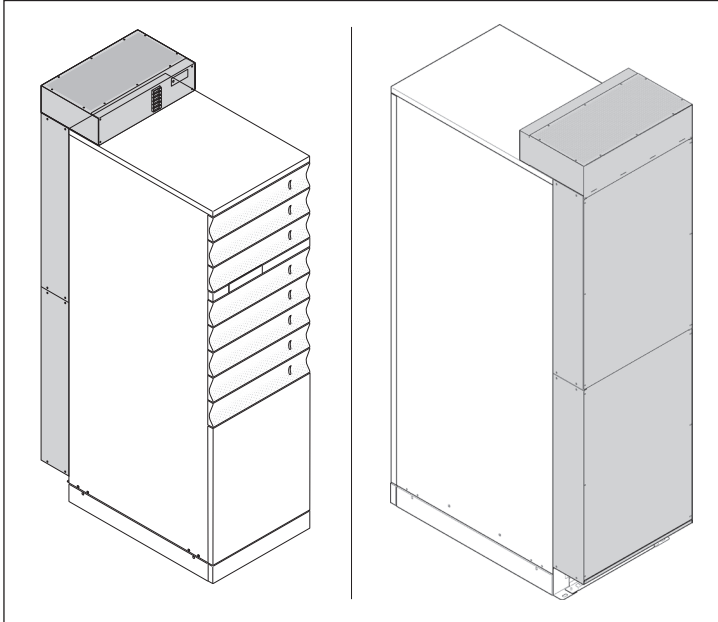

Environment

Acoustic noise according to ISO 3746	dBA	70
--------------------------------------	-----	----

11.10. Kit for IP21

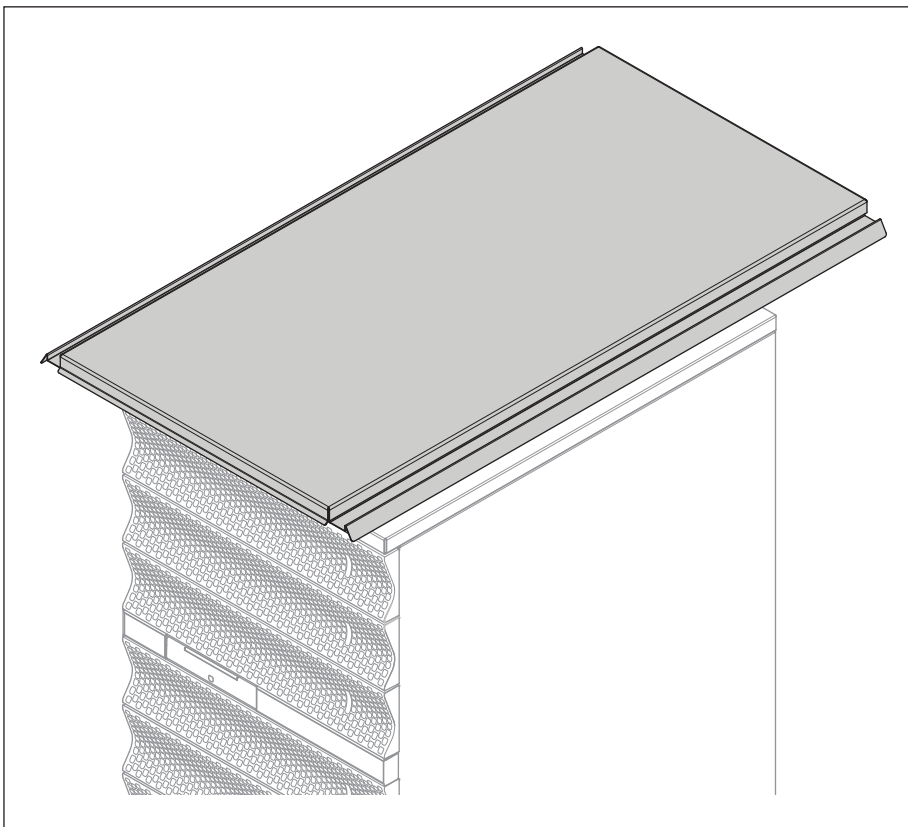

11.11. Top entry cables

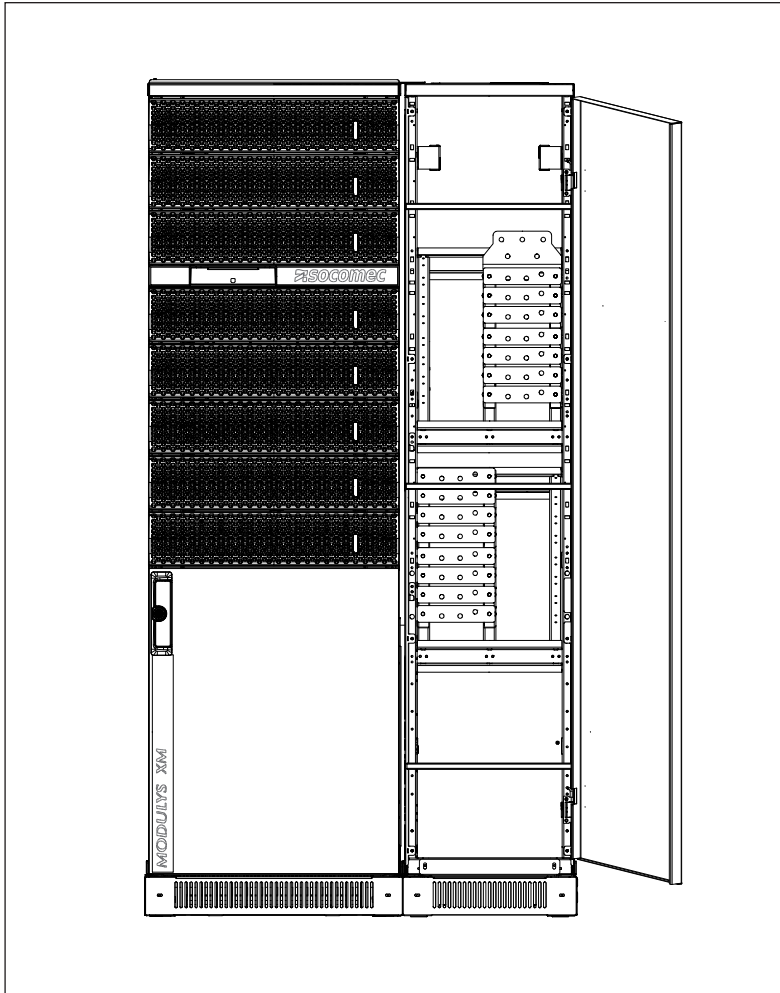

See the dedicated Installation and operating manual.

11.12. Kit for common mains

See 'Mains and auxiliary mains connected together' chapter.

11.13. Cold Start

During a prolonged mains failure the load is supplied by the UPS until the protection threshold is reached and the UPS switches off.

With the cold start option enabled, the user has 2 hours time to disconnect the non-essential load and restart manually the UPS (START PROCEDURE via HMI) directly in Stored Mode (battery mode) of operation (Cold Start) in order to supply the indispensable load by exploiting the available residual energy in batteries.

NO retry is possible after the first Cold Start procedure.

12. TROUBLESHOOTING

The alarm messages displayed enable immediate diagnosis.

Alarms are divided into two categories:

- Alarms relating to external UPS circuits: input mains, output mains, temperature and environment.
- Alarms relating to internal UPS circuits: in this case corrective action will be carried out by the After Sales Department.

The USB report makes it possible to have full information on what occurred. Refer to 'Display operation' chapter.

For other alarms that may appear please contact the Service Dept.

12.1. System alarms



A000	IMMINENT STOP	An imminent stop is about to happen. In few minutes the UPS will be shut down. This can be caused by a critical alarm or a user request.
A001	OVERLOAD ALARM	The load is exceeding the UPS power specification. The machine will turn off. Reduce the load immediately.
A002	AMBIENT TEMPERATURE ALARM	Environmental temperature is too high. UPS functionality may be affected, if the condition last for prolonged time.
A003	TRANSFER LOCKED	The UPS is unable to transfer the load between bypass and inverter.
A004	TRANSFER IMPOSSIBLE	Bypass is not available.
A005	INSUFFICIENT RESOURCES	Some components are not operational.
A006	REDUNDANCY LOST	The minimum number of modules that are needed to supply the load has been reached. Check Individual Module alarms or the load rate.
A008	ECO MODE DISABLED BY UPS	Eco mode is disabled due to bypass failure.
A009	ENERGY SAVER DISABLED BY UPS	An event has occurred forcing the UPS to stop the energy saver function.
A012	MAINTENANCE ALARM	UPS needs routine maintenance. Please contact the Service Department.
A013	REMOTE SERVICE ALARM	UPS needs immediate maintenance. Please contact the Service Department.
A014	REMOTE SERVICE PREVENTIVE ALARM	A non-critical alarm is present. Please contact the Service Department.
A015	GENERAL ALARM	An alarm is present.
A016	BATTERY DISCONNECTED	The battery is not connected to the UPS.
A017	BATTERY DISCHARGED	The Battery Charge Level is low and reached a warning threshold.
A018	END OF BACK-UP TIME	Supply from batteries is close to finishing.
A019	OPERATING ON BATTERY	The UPS is running on battery. Load is supplied by batteries.
A020	BATTERY TEMPERATURE ALARM	Battery temperature is greater than the threshold. If temperature is measured using ADC+SL, verify NTC is still connected, otherwise, check the internal UPS temperature.
A021	BATTERY ROOM ALARM	The battery cabinet temperature is too high.
A022	BATTERY TEST FAILED	The battery has failed the last battery test.
A026	INSULATION FAULT	There is an insulation problem with the plant. Verify input from ADC+SL.
A027	BATTERY ALARM	A battery alarm is present. Maximum recharging time at two levels, or slow discharging time protection has occurred.
A032	RECTIFIER CRITICAL ALARM	There is a problem with the rectifier. Please contact the Service Department.
A033	RECTIFIER PREVENTIVE ALARM	There is a non-critical problem with the rectifier. Please contact the Service Department.
A035	RECTIFIER INPUT SUPPLY NOT OK	The input mains supply is out of tolerance. Verify that the input voltage and frequency are within the UPS ratings.
A037	CHARGER CRITICAL ALARM	There is a problem with the battery charger. Please contact the Service Department.
A038	CHARGER PREVENTIVE ALARM	Battery charger was temporary stopped or Battery Voltage is too low.

A040	INVERTER CRITICAL ALARM	There is a problem with the inverter. Please contact the Service Department.
A041	INVERTER PREVENTIVE ALARM	There is a non-critical problem with the inverter. Check the fans are working properly. Please contact the Service Department.
A043	INVERTER IMMINENT STOP	Imminent redundancy was lost due to overload, unit imminent stop, etc.
A048	BYPASS CRITICAL ALARM	There is a problem with the bypass. Please contact the Service Department.
A049	BYPASS PREVENTIVE ALARM	There is a non-critical problem with the bypass. Please contact the Service Department.
A050	BYPASS INPUT SUPPLY NOT OK	The auxiliary supply is out of tolerance. Verify that the input voltage and frequency are within the UPS ratings.
A051	PHASE ROTATION FAULT	The auxiliary mains is not connected properly. Please check phase connection order is correct.
A052	BYPASS BACK-FEED DETECTION	There is a backfeed problem with the bypass. Please contact the Service Department.
A054	FAN FAILURE	Fan Failure can generate overheating. Please contact the Service Department.
A055	ACS ALARM	Communication between ACS and Inverter is lost.
A056	MAINTENANCE BYPASS ALARM	Output and Maintenance ByPass switches are closed at the same time.
A057	INTERNAL BACKFEED DETECTION	There is a backfeed problem with the rectifier. Please contact the Service Department.
A059	UPS POWER OFF	The UPO emergency input on ADC+SL has been activated.
A060	WRONG CONFIGURATION	UPS is not configured properly. Please check the configurations or contact the Service Department.
A061	INTERNAL / COMMUNICATION FAILURE	The internal communication between UPS sub-system is lost. Please contact the Service Department.
A062	OPTION BOARD ALARM	There is a communication problem with the option board. Please contact the Service Department.
A063	SPARE PARTS NOT COMPATIBLE	Please contact the Service Department.

12.2. System status

S002	LOAD SUPPLIED BY AUTOMATIC BYPASS	Load on bypass, supplied by auxiliary mains. Load not protected.
S018	EXTERNAL MAINTENANCE BYPASS CLOSED	External maintenance bypass input is closed.
S023	GEN SET ON	Genset input. Verify input from ADC+SL.
S064	CARD IN SLOT 1 PRESENT	
S065	CARD IN SLOT 2 PRESENT	
S068	CARD IN SLOT 3 PRESENT	

13. PREVENTIVE MAINTENANCE

	NOTE! Before carrying out any operations on the unit read the 'Safety standards' chapter carefully.
	NOTE! Any work carried out on the equipment must be performed by qualified technicians authorised by SOCOMEC.

Routine maintenance carried out annually is recommended in order to provide optimum operating efficiency and avoid equipment downtime.

Maintenance consists of thorough functionality checks on:

- electronic and mechanical parts;
- dust removal;
- battery inspection;
- software updating;
- environmental checks.



13.1. Batteries

The condition of the battery is fundamental to UPS operation.

During the operating lifetime of the battery, the UPS stores statistics on the conditions of use of the battery for analysis.

Expected battery lifetime is very much dependent on operating conditions:

- number of charging and discharging cycles;
- load rate;
- temperature.

	NOTE! Batteries must only be replaced with batteries recommended or sold by the manufacturer. Batteries must only be replaced by qualified technicians.
	BEWARE! Used batteries contain harmful substances. Do not open the plastic cover!
	NOTE! Used batteries have to be placed in the appropriate containers to avoid leakage acid. They should only be entrusted to a specialist waste disposal company.

13.2. Fans & capacitors

The lifespan of consumable parts such as fans and capacitors (AC and DC) depends on whether or not the use and environmental conditions (premises, usage or load type) are abnormal or harsh for the equipment.

It is advisable to replace consumables as follows⁽¹⁾:

Consumable part	Years
Fan	5
AC and DC capacitor	7

(1) Based on operation of the unit according to the manufacturer's specification.

14. SAFEGUARDING THE ENVIRONMENT

Do not dispose of electrical appliances with normal waste, use separate collection facilities.

Follow local council waste regulations for proper disposal arrangements to reduce the environmental impact of waste electrical and electronic equipment or contact your local government for information regarding the collection arrangements available.

If electrical appliances are disposed of in landfills or dumps, hazardous substances can leak into the groundwater and get into the food chain, damaging health and wellbeing. Depleted batteries are considered as toxic waste. When battery replacement becomes necessary, only give rundown batteries to certified and licensed waste disposal companies. In accordance with local legislation, it is prohibited to dispose of batteries together with other industrial waste or household refuse.



The crossed-out trash bin symbol is placed on this product to encourage users to recycle components and units whenever possible. Please be environmentally responsible and recycle this product through your recycling facility at the end of its lifetime.



For any questions regarding the disposal of the product, contact local distributors or retailers.

15. TECHNICAL SPECIFICATIONS

Number of modules			1	2	3	4	5	6
Power (N+1 redundant)	kW		50 + 0 ⁽¹⁾	50 + 50	100 + 50	150 + 50	200 + 50	250 + 50
	kVA		50 + 0 ⁽¹⁾	50 + 50	100 + 50	150 + 50	200 + 50	250 + 50
Input								
Input mains voltage			3ph + N 340 V to 480 V (+20/-15%) up to -40% @ 70% of nominal load					
Input mains frequency	Hz		40 to 70					
Input power factor			≥ 0.99 ⁽²⁾					
Total harmonic input current distortion (THDi)			≤ 3% (@: Pn, Resistive load, Mains THDv ≤ 1%)					
Output								
Output voltage (three phase + neutral)	V		3Ph+N 380/400/415 V ±1% ⁽³⁾					
Frequency	Hz		50-60 Hz (selectable) ±0.01%					
Total output voltage distortion (THDv)	%		≤ 1% (Ph/Ph); ≤ 2% (Ph/N) (@: Pn, Resistive load)					
Overload ⁽⁴⁾	10 min	kW	62.5	125	187.5	250	312.5	312.5
	1 min	kW	75	150	225	300	375	375
Crest Factor			≥ 2.7					
Bypass								
Bypass input voltage	V		Nominal output voltage ±15% (±20% if GENSET is used)					
Bypass input frequency	Hz		50/60 +/-2% selectable (±8% if GENSET is used)					
Stored energy mode of operation								
Battery voltage range	V bat		From +/-180 ⁽⁵⁾ up to +/-330 ⁽⁶⁾ (18+18 to 24+24 VRLA battery blocks) ⁽⁷⁾					
Environmental								
Operating temperature	°C		0-40 °C (+15 °C to +30 °C recommended)					
Storage temperature	°C		-25 °C to +55 °C					
Relative humidity	%		95% condensation-free					
Altitude (max)	m		1000 (3000 with derating)					
Acoustic noise (@ 70% Pn)	dBA		50	49	50	55	56	57
Cooling type			Air cooling					
Required cooling capacity	m ³ /h		600	1200	1800	2400	3000	3600
Dissipated power (max)	W		2580	2140	4390	6910	9430	12060
Dissipated power (max)	BTU/h		8810	7310	14980	23580	32180	41160
Dimensions and Weight								
Dimensions (W x D x H)	mm		600 x 890 x 1990					
M5-S-300-82 (1x Bypass module included)	kg		289	325	361	397	433	469
M5-S-300-88 (2x Bypass modules included)	kg		313	349	385	421	457	493
UPS module	kg		36					
Standard								
Safety			EN/IEC 62040-1 - AS 62040-1					
EMC			EN/IEC 62040-2 - AS 62040-2					
Product certification			IECEE CB Scheme					
Performance			EN/IEC 62040-3 - AS 62040-3					
Product marks			CE - RCM ⁽⁸⁾ - EAC ⁽⁸⁾ - CMIM ⁽⁸⁾ - UKCA ⁽⁸⁾					
Protective class			Protective Class I					
Touch current			< 1 mA					
Protection level			IP20					

(1) No redundancy

(2) Pout ≥ 50% Sn

(3) 360 V with Pout = 90% Pn

(4) Initial Condition Pout ≤ 80% Pn

(5) @ Battery Fully Discharged. Call SOCOMEC support service

(6) @ Battery Fully Charged. Call SOCOMEC support service

(7) Condition apply. For further information contact SOCOMEC

(8) Depends on the production site. Consult the data plate on the equipment

CORPORATE HQ CONTACT:
SOCOMEC SAS
1-4 RUE DE WESTHOUSE
67235 BENFELD, FRANCE

www.socomec.com

Non contractual document. © 2024, Socomec SAS. All rights reserved.



552257D



 **socomec**
Innovative Power Solutions